

# Værktøjsvogn og skumgummiindsatser

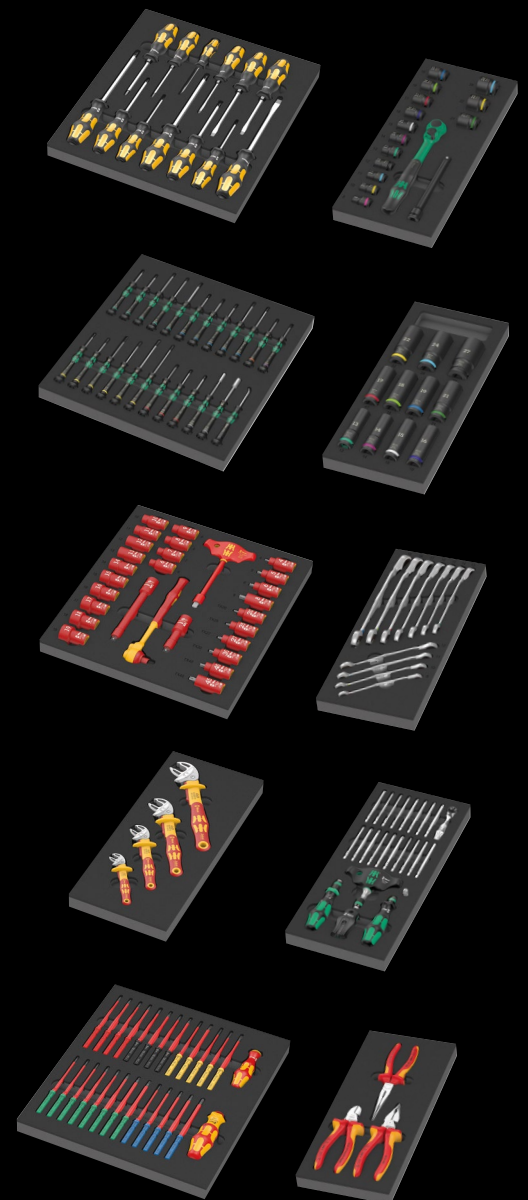

## Udstyret værktøjsvogn med genialt front-design i absolut topkvalitet.

- Eksklusiv værktøjsvogn i Tool Rebel design
- Ekstrem robust udførelse via dobbeltvægget konstruktion
- Med 7 skuffer (5 flade, 2 dybe) – deraf 2 flade skuffer udstyret med skumgummiindsatser og værktøj
- Mål flade skuffer (bredde x højde x dybde): 522 x 81 x 398 mm
- Mål for dybe skuffer (bredde x højde x dybde): 522 x 166 x 398 mm
- 100 %'s skuffe-udtræk med kuglelagrede teleskopskinner, selvindtræk
- Alle skuffer er omhyggeligt folieret enkeltvis
- Minimal vælterisiko via udtrækslås – der kan kun åbnes én skuffe ad gangen, ingen samtidig udtræk af flere skuffer
- Kvalitets skumgummiindsatser med lang levetid uden kemiske dampe
- Optimal pasform til bedstmulig udtagning af værktøjet fra skumgummiindsatserne





## 9700 Tool Rebel værktøjsvogn 1



Eksklusiv værktøjsvogn i Tool Rebel design. 5 flade og 2 dybe skuffer sørger for en effektiv, mobil organisation af værktøj og materialer. Ekstrem robust udførelse via dobbeltvægsudførelse og komplet svejst konstruktion af hele korpus. Til den daglige hårde værkstedsindsats. Udstyret med 4 Wera skumgummiindlæg: 9710 skumgummiindlæg skruestrækker sæt 1, 9720 skumgummiindlæg 8000 A Zyklop skralde sæt 1, 9731 skumgummiindlæg 6003 Joker ringgaffelnøgle sæt 1, 9740 skumgummiindlæg vinkelnøgle sæt 1.

05150130001 1x 9700 Tool Rebel værktøjsvogn 1

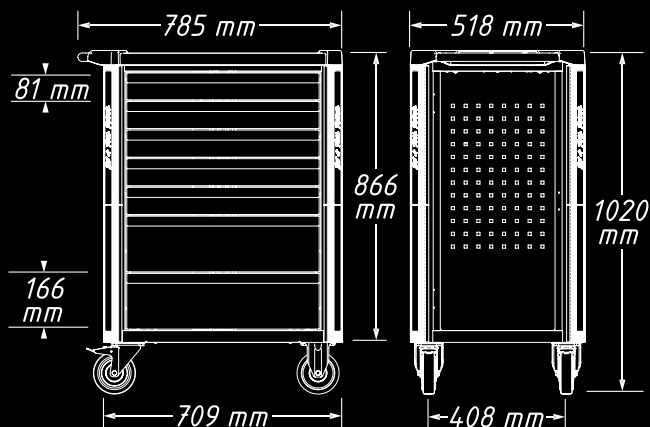

## Inklusiv følgende skumgummiindsatser:

9710



9720

1/4"

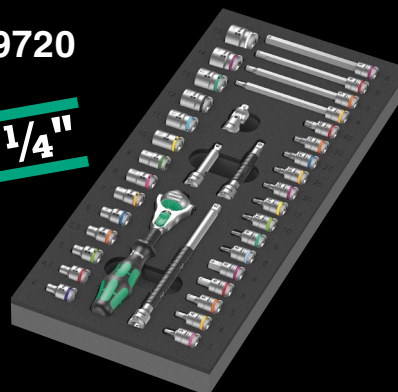

9731

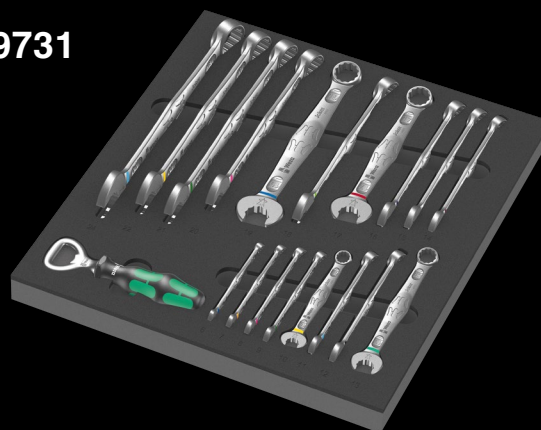

9740



## NYHED

### 9714 Skumgummiindsats skruemejslen skruetrækker sæt 1

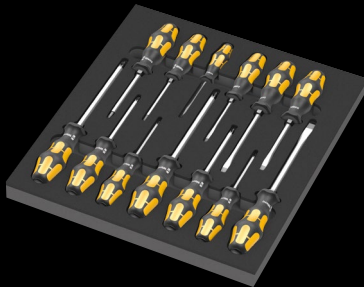

05150105001		
+	917 SPH	1x PH 1x80; 1x PH 2x100; 1x PH 3x150
+	918 SPZ	1x PZ 1x80; 1x PZ 2x100; 1x PZ 3x150
-	932 A	1x 0,6x3,5x80 <sup>1)</sup> ; 1x 0,8x4,5x90; 1x 1,0x5,5x100; 1x 1,2x7,0x125; 1x 1,6x9,0x150
+	977 TORX®	1x TX 20x90; 1x TX 25x100
	9814	1x 344,0x30,0x392,0

<sup>1)</sup> Uden gennemgående klinge, slagkappe og sekskant til fastnøgle

## NYHED

### 9715 Skumgummiindsats skruetrækkere Kraftform Micro sæt 1

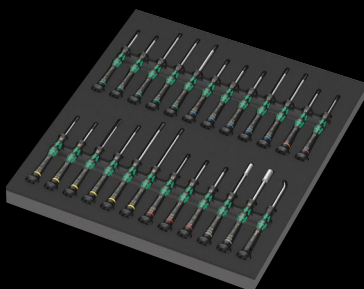

05150106001		
+	2050 Micro	1x PH 000x40 <sup>1) 2)</sup> ; 1x PH 00x40 <sup>1) 2)</sup> ; 1x PH 0x40 <sup>3)</sup>
+	2067 TORX® HF	1x TX 5x40; 1x TX 6x40; 1x TX 7x60; 1x TX 8x60; 1x TX 10x60
+	2067 TORX PLUS® IPR Micro	1x 1 IPRx40 <sup>4)</sup>
+	2072 Micro	1x mx40
+	2054 Micro	1x 0,7x40; 1x 0,9x40; 1x 1,3x40; 1x 1,5x60; 1x 2x60
-	2035 Micro	1x 0,23x1,5x40; 1x 0,30x1,8x60; 1x 0,35x2,5x40; 1x 0,40x2,0x60; 1x 0,40x2,5x80; 1x 0,50x3,0x80
+	2069 Micro	1x 4,0x60; 1x 5,5x60
+	1429	1x 1,0x3,5x50
	9815	1x 344,0x30,0x392,0

<sup>1)</sup> Optimeret til asiatiske PH skruer

<sup>2)</sup> Klinge drejet ned på det nominelle mål over en længde af 10 mm på udgangssiden

<sup>3)</sup> Størrelse 0 modificeret svarende til JCS 0 (Japanese Camera Industrial Standard)

<sup>4)</sup> Uden boring

## NYHED

### 9726 Skumgummiindsats 8007 B VDE Zyklop VDE skralde sæt 1, 3/8"

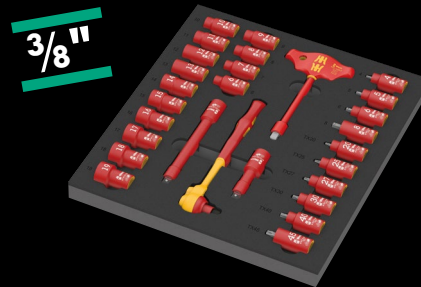

05150116001		
○	8007 B VDE	1x 3/8"x222,0
○	410 i VDE B	1x 3/8"x130
●	8790 B VDE	1x 6,0x46,0; 1x 7,0x46,0; 1x 8,0x46,0; 1x 9,0x46,0; 1x 10,0x46,0; 1x 11,0x46,0; 1x 12,0x46,0; 1x 13,0x46,0; 1x 14,0x46,0; 1x 15,0x46,0; 1x 16,0x46,0; 1x 17,0x46,0; 1x 18,0x46,0; 1x 19,0x46,0
+	8767 B VDE HF	1x TX 20x55,0; 1x TX 25x55,0; 1x TX 27x55,0; 1x TX 30x55,0; 1x TX 40x55,0; 1x TX 45x59,0
○	8740 B VDE HF	1x 4,0x55,0; 1x 5,0x55,0; 1x 6,0x55,0; 1x 8,0x59,0
○	8794 SB VDE	1x 3/8"x91,0
○	8794 LB VDE	1x 3/8"x166,0
	9826	1x 344,0x30,0x392,0

## NYHED

### 9734 Skumgummiindsats 6004 Joker VDE sæt 1



05150124001		
	6004 Joker VDE XS	1x 7-10 (1/4"-3/8")x119
	6004 Joker VDE S	1x 10-13 (7/16"-1/2")x155
	6004 Joker VDE M	1x 13-16 (1/2"-5/8")x190
	6004 Joker VDE L	1x 16-19 (5/8"-3/4")x226
	9834	1x 172,0x30,0x392,0

**Bemærk: Skumgummiindsatserne passer ikke i værktøjsvognens forgængermodel 05501051001.**

## NYHED

### 9751 Skumgummiindsats Kraftform Kompakt VDE sæt 1

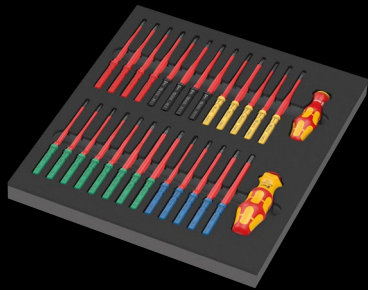

05150151001		
●	837 i RA	1x 9x115
●	817 VDE	1x 9x98
⊕	Kraftform Kompakt VDE 62 iS Take it easy	1x PH 1x157; 1x PH 2x157
⊕	Kraftform Kompakt VDE 65 iS Take it easy	1x PZ 1x157; 1x PZ 2x157
⊕	Kraftform Kompakt VDE 62 iS PH/S Take it easy	1x # 1x157; 1x # 2x157
⊕	Kraftform Kompakt VDE 65 iS PZ/S Take it easy	1x # 1x157; 1x # 2x157
⊕	Kraftform Kompakt VDE 67 i Take it easy	1x TX 8x157; 1x TX 9x157; 1x TX 10x157; 1x TX 27x157; 1x TX 30x157
⊕	Kraftform Kompakt VDE 67 iS Take it easy	1x TX 15x157; 1x TX 20x157; 1x TX 25x157
○	Kraftform Kompakt VDE 64 i Take it easy	1x 2,5x157; 1x 3,0x157; 1x 4,0x157; 1x 5,0x157; 1x 6,0x157
⊖	Kraftform Kompakt VDE 60 iS Take it easy	1x 0,6x3,5x157; 1x 0,8x4,0x157; 1x 1,0x5,5x157
⊖	Kraftform Kompakt VDE 60 i Take it easy	1x 0,4x2,5x157; 1x 1,2x6,5x157
	9851	1x 344,0x30,0x392,0

## NYHED

### 9724 Skumgummiindsats 8010 B Zyklop Comfort skralde sæt 1, 3/8"



05150114001		
○	8010 B	1x 3/8"x230,0
●	8790 B Impaktor	1x 8,0x30,0; 1x 10,0x30,0; 1x 11,0x30,0; 1x 12,0x30,0; 1x 13,0x30,0; 1x 14,0x30,0; 1x 15,0x30,0; 1x 16,0x30,0; 1x 17,0x30,0; 1x 18,0x30,0; 1x 19,0x30,0; 1x 21,0x32,0; 1x 22,0x32,0; 1x 24,0x32,0
⊖	8798 B	1x 3/8"x152,4
	9824	1x 172,0x30,0x392,0

## NYHED

### 9725 Skumgummiindsats Zyklop C, 1/2", Impaktor Deep topnøgleindsats sæt 1

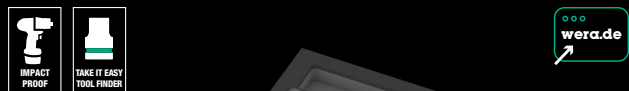

05150115001		
●	8790 C Impaktor Deep	1x 13,0x83,0; 1x 14,0x83,0; 1x 15,0x83,0; 1x 16,0x83,0; 1x 17,0x83,0; 1x 18,0x83,0; 1x 19,0x83,0; 1x 21,0x83,0; 1x 22,0x83,0; 1x 24,0x83,0; 1x 27,0x83,0
	9825	1x 172,0x30,0x392,0

## NYHED

### 9733 Skumgummiindsats 6001 Joker Switch sæt 1

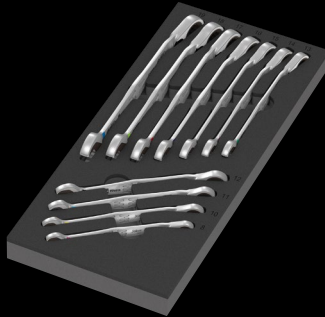

05150123001	
6001 Joker Switch	1x 8x144; 1x 10x159; 1x 11x165; 1x 12x171; 1x 13x179; 1x 14x187; 1x 15x199; 1x 16x213; 1x 17x225; 1x 18x234; 1x 19x246
9833	1x 172,0x30,0x392,0

## NYHED

### 9784 Skumgummiindsats KNIPEX tang sæt VDE 1



05150184001	
KNIPEX skævbider 70 06 160	
KNIPEX fladrundtang med skær (storkenæbstang) 26 16 200	
KNIPEX spids-kombinationstang 08 26 185	
9884	1x 172,0x30,0x392,0

## NYHED

### 9752 Skumgummiindsats Kraftform Kompakt skralde-sæt 1



1/4"

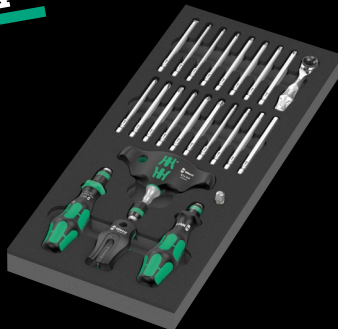

05150152001	
838 RA-R M	1x 1/4"x123,5
416 RA	1x 1/4"x45
816 R	1x 1/4"x119
8001 A	1x 1/4"x87,0
851/4 Z	1x PH 1x89; 1x PH 2x89; 1x PH 3x89 <sup>1)</sup>
855/4 Z	1x PZ 1x89; 1x PZ 2x89; 1x PZ 3x89 <sup>1)</sup>
867/4 Z TORX®	1x TX 10x89; 1x TX 15x89; 1x TX 20x89; 1x TX 25x89; 1x TX 27x89; 1x TX 30x89; 1x TX 40x89
840/4 Z	1x 3,0x89; 1x 4,0x89; 1x 5,0x89; 1x 6,0x89 <sup>1)</sup>
800/4 Z	1x 1,0x5,5x89
870/1	1x 1/4"x25 <sup>2)</sup>
9500	1x 64,6
9852	1x 172,0x30,0x392,0

### 9710 Skumgummiindsats skruetrækker sæt 1



05150101001	
932 A	1x 1,0x5,5x100; 1x 1,2x7,0x125
350 PH	1x PH 1x80; 1x PH 2x100; 1x PH 3x150
350 PH Stubby	1x PH 2x25
355 PZ	1x PZ 1x80; 1x PZ 2x100
335	1x 0,8x4,0x100; 1x 1,0x5,5x125
334	1x 1,2x6,5x150
335 Stubby/ karburator-skruetrækker	1x 1,0x5,5x24,5
2050 Micro	1x PH 0x40 <sup>1)</sup>
2035 Micro	1x 0,40x2,5x80
160 i VDE	1x 0,4x2,5x80 <sup>2)</sup> ; 1x 0,6x3,5x100 <sup>2)</sup>
1441	1x 4,5-6,0x41,0
1442	1x 6,0-8,5x41,0
9810	1x 344,0x30,0x392,0

<sup>1)</sup> Størrelse 0 modificeret svarende til JCIS 0 (Japanese Camera Industrial Standard)

<sup>2)</sup> ikke Lasertip

<sup>1)</sup> Sekskantsklinge

<sup>2)</sup> Med kugle; til manuelt førte topnogleindsatser

## 9711 Skumgummiindsats VDE skruetrækker sæt 1

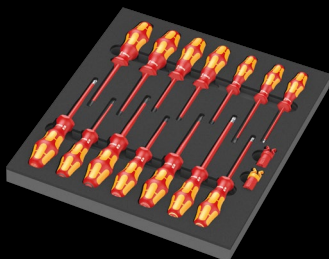

05150102001	
+	162 iS PH VDE 1x PH 1x80; 1x PH 2x100
+	165 iS PZ VDE 1x PZ 1x80; 1x PZ 2x100
+	165 i PZ/S VDE 1x # 2x100
-	160 i VDE 1x 0,4x2,5x80 <sup>1)</sup> ; 1x 0,8x4,0x100; 1x 1,0x5,5x125
-	160 iS VDE 1x 0,6x3,5x100
+	167 i TORX® VDE 1x TX 10x80; 1x TX 15x80; 1x TX 20x80; 1x TX 25x100; 1x TX 30x100
	1440 1x 4,5-6,0x41,0
	1442 1x 6,0-8,5x41,0
	9811 1x 344,0x30,0x392,0

<sup>1)</sup> ikke Lasertip

## 9713 Skumgummiindsats Hex skruetrækker sæt 1

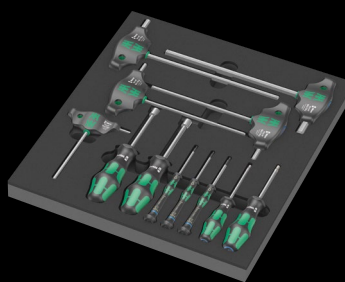

05150104001	
○	354 1x 3,0x75; 1x 4,0x75
○	2054 Micro 1x 1,5x60; 1x 2x60; 1x 2,5x60
○	454 HF 1x 4x100; 1x 5x100; 1x 6x150; 1x 8x200; 1x 10x200
●	395 H0 1x 10,0x90; 1x 13,0x90
	9813 1x 344,0x30,0x392,0

## 9720 Skumgummiindsats 8000 A Zyklop skralde 1/4" sæt 1



## 9712 Skumgummiindsats TORX® HF skruetrækker sæt 1

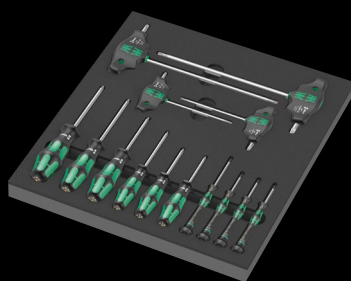

05150103001	
+	367 TORX® HF 1x TX 8x60; 1x TX 9x60; 1x TX 10x80; 1x TX 15x80; 1x TX 20x100; 1x TX 25x100
+	2067 TORX® HF 1x TX 4x40; 1x TX 5x40; 1x TX 6x40; 1x TX 7x60
+	467 TORX® HF 1x TX 20x100; 1x TX 25x100; 1x TX 30x200; 1x TX 40x200
	9812 1x 344,0x30,0x392,0

05150110001	
○	8000 A 1x 1/4"x152,0
●○	8794 LA 1x 1/4"x150,0
●○	8794 SA 1x 1/4"x75,0
●○	8795 A 1x 1/4"x35,5
●○	8794 A 1x 1/4"x56,0
●	8790 HMA 1x 4,0x23,0; 1x 4,5x23,0; 1x 5,0x23,0; 1x 5,5x23,0; 1x 6,0x23,0; 1x 7,0x23,0; 1x 8,0x23,0; 1x 9,0x23,0; 1x 10,0x23,0; 1x 11,0x23,0; 1x 12,0x23,0; 1x 13,0x23,0; 1x 14,0x23,0; 1x 15,0x23,0
+	8767 A HF 1x TX 8x28,0; 1x TX 9x28,0; 1x TX 10x28,0; 1x TX 15x28,0; 1x TX 20x28,0; 1x TX 25x28,0; 1x TX 27x28,0; 1x TX 30x28,0; 1x TX 40x28,0
○	8740 A HF 1x 3,0x28,0; 1x 4,0x28,0; 1x 4,0x100,0; 1x 5,0x28,0; 1x 5,0x100,0; 1x 6,0x28,0; 1x 6,0x100,0; 1x 8,0x28,0; 1x 8,0x100,0
	9820 1x 172,0x30,0x392,0



## 9721 Skumgummiindsats 8000 B Zyklop skalde 3/8" sæt 1



05150111001		
○	8000 B	1x 3/8"x199,0
●○	8794 SB	1x 3/8"x125,0
●○	8794 LB	1x 3/8"x200,0
●○	8795 B	1x 3/8"x50,0
●○	8794 B	1x 3/8"x76,0
●	8790 HMB	1x 6,0x29,0; 1x 7,0x29,0; 1x 8,0x29,0; 1x 9,0x29,0; 1x 10,0x29,0; 1x 11,0x29,0; 1x 12,0x29,0; 1x 13,0x29,0; 1x 14,0x29,0; 1x 15,0x29,0; 1x 16,0x30,0; 1x 17,0x30,0; 1x 18,0x30,0; 1x 19,0x30,0; 1x 20,0x30,0; 1x 21,0x30,0; 1x 22,0x30,0; 1x 24,0x32,0
	9821	1x 172,0x30,0x392,0

## 9723 Skumgummiindsats Zyklop B 3/8" bittop sæt 1



05150113001		
●●	8784 B1	1x 1/4"x3/8"x44,0
⊗	8767 B HF	1x TX 15x35,0; 1x TX 20x35,0; 1x TX 25x35,0; 1x TX 25x107,0; 1x TX 27x35,0; 1x TX 27x107,0; 1x TX 30x35,0; 1x TX 30x107,0; 1x TX 40x35,0; 1x TX 40x107,0
○	8740 B HF	1x 4,0x35,0; 1x 4,0x107,0; 1x 5,0x35,0; 1x 5,0x107,0; 1x 6,0x35,0; 1x 6,0x107,0; 1x 7,0x38,5; 1x 8,0x38,5; 1x 8,0x100,0; 1x 10,0x38,5; 1x 10,0x100,0
	9823	1x 172,0x30,0x392,0

## 9722 Skumgummiindsats 8000 C Zyklop skalde 1/2" sæt 1



05150112001		
○	8000 C	1x 1/2"x277,0
●○	8794 LC	1x 1/2"x250,0
●○	8794 SC	1x 1/2"x125,0
●○	8795 C	1x 1/2"x69,0
●○	8794 C	1x 1/2"x52,0
●	8790 HMC	1x 10,0x37,0; 1x 11,0x37,0; 1x 12,0x37,0; 1x 13,0x37,0; 1x 14,0x37,0; 1x 15,0x37,0; 1x 16,0x37,0; 1x 17,0x37,0; 1x 18,0x37,0; 1x 19,0x37,0; 1x 20,0x37,0; 1x 21,0x37,0; 1x 22,0x37,0; 1x 24,0x37,0; 1x 27,0x40,0; 1x 30,0x42,0; 1x 32,0x42,0
○	8740 C HF	1x 4,0x60,0; 1x 4,0x140,0; 1x 5,0x60,0; 1x 5,0x140,0; 1x 6,0x60,0; 1x 6,0x140,0; 1x 7,0x60,0; 1x 8,0x60,0; 1x 10,0x60,0
	9822	1x 344,0x30,0x392,0

## 9730 Skumgummiindsats 6000 Joker Set 1

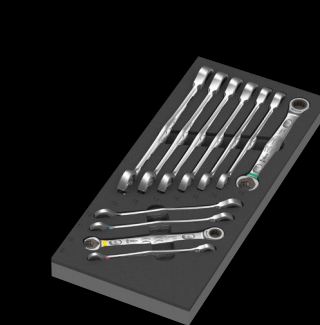

05150120001		
	6000 Joker	1x 8x144; 1x 10x159; 1x 11x165; 1x 12x170,7; 1x 13x177; 1x 14x188; 1x 15x200; 1x 16x212; 1x 17x224; 1x 18x235; 1x 19x246
	9830	1x 172,0x30,0x392,0

## 9731 Skumgummiindsats 6003 Joker Set 1



05150121001		
	<b>6003 Joker</b>	1x 6x105; 1x 7x110; 1x 8x115; 1x 9x120; 1x 10x125; 1x 11x135; 1x 12x148; 1x 13x160; 1x 14x167; 1x 15x174; 1x 16x182; 1x 17x190; 1x 18x210; 1x 19x230,0; 1x 20x230,0; 1x 21x260; 1x 22x260; 1x 24x280
	<b>Øloplukker</b>	1x 148
	<b>9831</b>	1x 344,0x30,0x392,0

## 9732 Skumgummiindsats 6004 Joker Set 1



05150122001		
	<b>6004 Joker XS</b>	1x 7-10 (1/4"-3/8")x117
	<b>6004 Joker S</b>	1x 10-13 (7/16"-1/2")x154
	<b>6004 Joker M</b>	1x 13-16 (1/2"-5/8")x188
	<b>6004 Joker L</b>	1x 16-19 (5/8"-3/4")x224
	<b>6004 Joker XL</b>	1x 19-24x (3/4"-15/16")x256
	<b>9832</b>	1x 172,0x30,0x392,0

## 9740 Skumgummiindsats vinkelnøglesæt 1

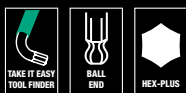

	<b>9840</b>	1x 172,0x30,0x392,0

## 9750 Skumgummiindsats Kraftform Kompakt og Tool-Check PLUS Set 1



05150150001		
	<b>1x Tool-Check PLUS</b>	
	● <b>8001 A</b>	1x 1/4"x87,0
	● <b>813</b>	1x 1/4"x78
	● <b>889/4/1 K</b>	1x 1/4"x50
	○ <b>870/1</b>	1x 1/4"x25 <sup>1)</sup>
	● <b>8790 HMA</b>	1x 5.5x23,0; 1x 6.0x23,0; 1x 7.0x23,0; 1x 8.0x23,0; 1x 10.0x23,0; 1x 12.0x23,0; 1x 13.0x23,0
	⊕ <b>851/1 TZ</b>	2x PH 1x25; 3x PH 2x25; 1x PH 3x25
	⊕ <b>855/1 TH</b>	1x PZ 1x25; 3x PZ 2x25; 1x PZ 3x25
	⊗ <b>867/1 TZ TORX®</b>	1x TX 10x25; 1x TX 15x25; 1x TX 20x25; 1x TX 25x25; 1x TX 30x25; 1x TX 40x25
	⊗ <b>867/1 Z TORX® BO</b>	1x TX 10x25; 1x TX 15x25; 1x TX 20x25; 1x TX 25x25; 1x TX 30x25
	○ <b>840/1 Z</b>	1x 3.0x25; 1x 4.0x25; 1x 5.0x25; 1x 6.0x25; 1x 8.0x25
	⊖ <b>800/1 TZ</b>	1x 1.0x5.5x25
	<b>1x Kraftform Kompakt 60</b>	
	● <b>816 R</b>	1x 1/4"x119
	⊕ <b>851/4 Z</b>	1x PH 1x89; 1x PH 2x89; 1x PH 3x89 <sup>2)</sup>
	⊕ <b>855/4 Z</b>	1x PZ 1x89; 1x PZ 2x89; 1x PZ 3x89 <sup>2)</sup>
	⊗ <b>867/4 Z TORX® BO</b>	1x TX 10x89; 1x TX 15x89; 1x TX 20x89; 1x TX 25x89; 1x TX 30x89
	⊖ <b>800/4 Z</b>	1x 1.0x5.5x89
	○ <b>840/4 Z</b>	1x 3.0x89; 1x 4.0x89; 1x 5.0x89; 1x 6.0x89 <sup>2)</sup>
	<b>Dobbelthæftende-stribe 70</b>	1x 50.0x70.0
	<b>1x 393 S</b>	
	●	1x 1/4"x173,5
	<b>1x 9850</b>	
		1x 172,0x30,0x392,0

<sup>1)</sup> Med kugle; til manuelt førte topnøgleindsats  
<sup>2)</sup> Sekskantklinge

05150140001		
	<b>1x 950/9 Hex-Plus Multicolour 1</b>	
	○ <b>950 SPKL Multicolour</b>	1x 1.5x90; 1x 2.0x101; 1x 2.5x112; 1x 3.0x123; 1x 4.0x137; 1x 5.0x154; 1x 6.0x172; 1x 8.0x195; 1x 10.0x224
	<b>1x 967/9 TX XL Multicolour 1</b>	
	⊗ <b>967 SXL TORX® Multicolour</b>	1x TX 8x90; 1x TX 9x101; 1x TX 10x112
	⊗ <b>967 SPKXL TORX® Multicolour</b>	1x TX 15x123; 1x TX 20x137; 1x TX 25x154; 1x TX 27x172; 1x TX 30x195; 1x TX 40x224
	<b>1x 9500</b>	
		1x 64,6
	<b>1x STABILA® lommemålebånd BM 100, 3 m, artikel 19570</b>	
		1x 3000,0
	<b>1x 9840</b>	
		1x 172,0x30,0x392,0

### 9780 Skumgummiindsats KNIPEX tang sæt 1



05150180001		
	KNIPEX kombinationstang 03 05 180	1x 180
	KNIPEX Cobra® High-tech-vand-pumpetang 87 05 250	1x 250
	KNIPEX Kraft-skævbidder 74 05 160	1x 160
9880		1x 172,0x30,0x392,0

### 9782 Skumgummiindsats Hammer Set 1



05150182001		
	PICARD® smedehammer 500 g, 0000101-500	1x 500,0
	RENNSTEIG drivdorn	1x 452 003 6 RC, 3,0x150; 1x4520046RC, 4,0x150; 1x4520066RC, 6,0x150;
	RENNSTEIG flad mejsel 310 250 1	1x 452 008 6 RC, 8,0x150
9882		1x 25,0x13,0x23,0
		1x 172,0x30,0x392,0

### 9781 Skumgummiindsats KNIPEX tang sæt 2

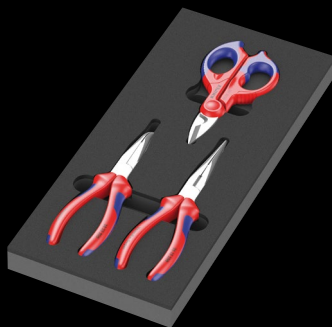

05150181001		
	KNIPEX flad-rundtang med skær (storknæbstang) 26 15 200	1x 200
	KNIPEX mekannikertang 38 25 200	1x 200
	KNIPEX elektrikersaks 95 05 155	1x 155
9881		1x 172,0x30,0x392,0

### 9783 Skumgummiindsats PFERD file sæt 1

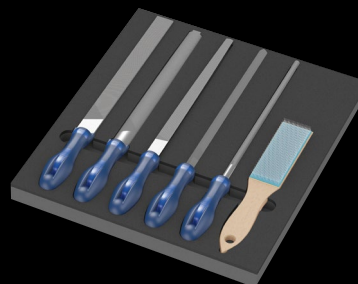

05150183001		
	PFERD værkstedsfil firkant PF1142 250 H2	1x 250
	PFERD værkstedsfil halvrund-spids 1152SP 250 H2	1x 250
	PFERD værkstedsfil rund 1162 250 H2	1x 250
	PFERD værkstedsfil fladendet 1112 250 H2	1x 250
	PFERD værkstedsfil trekant 1132 250 H2	1x 250
	PFERD filbørste HBF ståltråd Ø 0,15	1x 232
9883		1x 344,0x30,0x392,0

Vi forbeholder os retten til uden bebudelse forud og til enhver tid at ændre alle i dette katalog anførte angivelser mht. produktens egenskaber, varianter og udførelser. Der hæftes udtrykkeligt ikke for trykfejl og andre fejl.



Wera Werkzeuge GmbH  
Korzenter Straße 21-25  
D-42349 Wuppertal

Phone: +49 (0)202/4045-0  
E-Mail: [info@wera.de](mailto:info@wera.de)  
[www.wera.de](http://www.wera.de)