

ツールトローリーと内装スポンジ ジフォーム

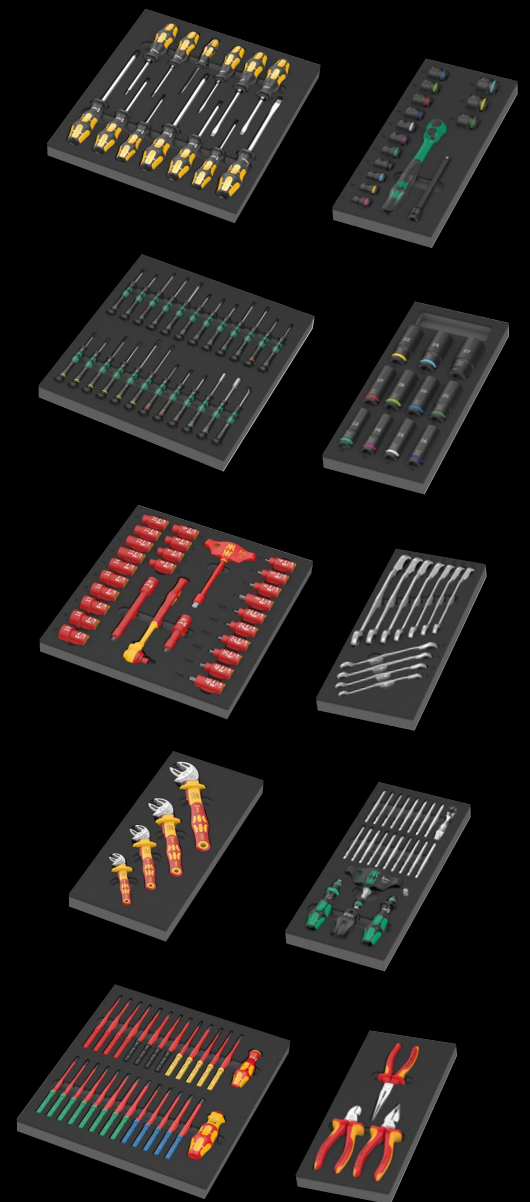

最高品質の見事なフロントデザインを備えたツールトローリー。

- Tool Rebelデザインのツールトローリー
- 二重成形のデザインのため頑丈な設計
- 7つの引き出し（薄型5点、ディープ2点）—うち2つの薄型引き出しには、内装スポンジフォームとツール
- 薄型引き出しの寸法（幅x高さx奥行）：
522 x 81 x 398 mm
- ディープ引き出しの寸法（幅x高さx奥行）：
522 x 166 x 398 mm
- スライド用ベアリング付引き出し、自動閉鎖
- すべての引き出しにスポンジフォームが付いている
- 引き出しのストップ機能付で傾くリスクを最小限に抑える—開くことができる引き出しは1つだけで、複数の引き出しを同時に引き出すことはできない
- 化学ガスフリー高品質で耐久性のある内装スポンジフォーム
- 内装スポンジフォームに工具がフィットするため、工具を取り出す作業も、快適







次の内装スポンジフォームを含む：

9710



9720

1/4"

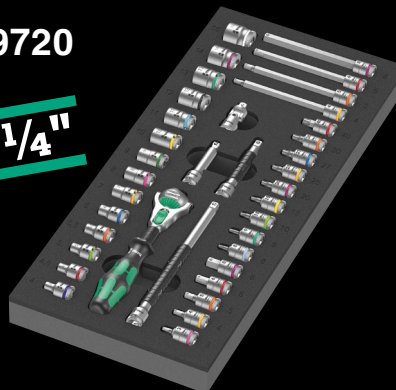

9731



9740



Tool Rebelデザインのツールトロリー。5つの薄型引き出しと2つのディープ引き出しは、工具と材料を効率的に収納可能。二重成形のデザインと完全溶接構造のため頑丈な設計。作業場での日々のハードワークに。4つのヴェラ内装スポンジフォーム付：9710 内装スポンジフォームドライバーセット1、9720 内装スポンジフォーム8000 A Zyklopラチェットセット1、9731内装スポンジフォーム6003 Jokerメガネスパナセット1、9740 内装スポンジフォームL型レンチセット1。

05150130001 1x 9700 Tool Rebel ツールトロリー 1

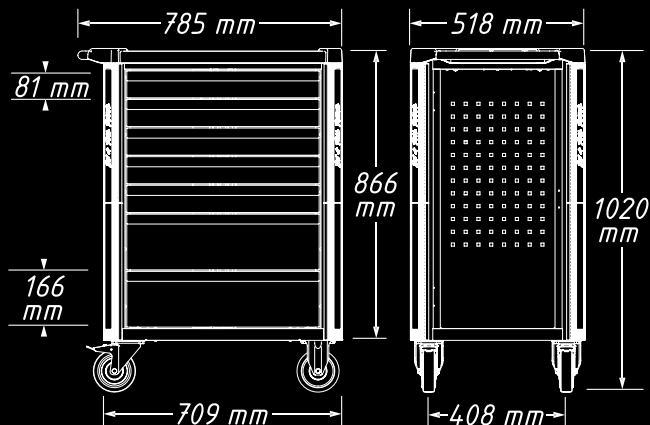

新品

9714 内装スポンジフォーム チゼルドライバーセット1



05150105001		
+	917 SPH	1x PH 1x80; 1x PH 2x100; 1x PH 3x150
+	918 SPZ	1x PZ 1x80; 1x PZ 2x100; 1x PZ 3x150
-	932 A	1x 0,6x3,5x80 ¹⁾ ; 1x 0,8x4,5x90; 1x 1,0x5,5x100; 1x 1,2x7,0x125; 1x 1,6x9,0x150
+	977 TORX®	1x TX 20x90; 1x TX 25x100
	9814	1x 344,0x30,0x392,0

¹⁾ 丸軸ブレード、耐衝撃のキャップ、六角ボルスターは施されておりません。

新品

9715 内装スポンジフォーム Kraftform マイクロドライバーセット1

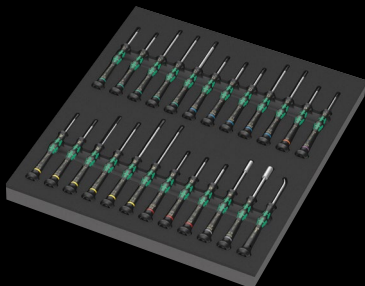

05150106001		
+	2050 Micro	1x PH 000x40 ^{1) 2)} ; 1x PH 00x40 ^{1) 2)} ; 1x PH 0x40 ³⁾
+	2067 TORX® HF	1x TX 5x40; 1x TX 6x40; 1x TX 7x60; 1x TX 8x60; 1x TX 10x60
+	2067 TORX PLUS® IPR Micro	1x 1 IPRx40 ⁴⁾
+	2072 Micro	1x mx40
+	2054 Micro	1x 0,7x40; 1x 0,9x40; 1x 1,3x40; 1x 1,5x60; 1x 2x60
-	2035 Micro	1x 0,23x1,5x40; 1x 0,30x1,8x60; 1x 0,35x2,5x40; 1x 0,40x2,0x60; 1x 0,40x2,5x80; 1x 0,50x3,0x80
+	2069 Micro	1x 4,0x60; 1x 5,5x60
+	1429	1x 1,0x3,5x50
	9815	1x 344,0x30,0x392,0

¹⁾ アジアでの汎用プラスネジに最適化

²⁾ 刃先側のブレードの軸径は10mmまで細く切削しました

³⁾ JCS 0 (日本カメラ工業規格) に沿ってサイズ0を調整

⁴⁾ いじり止め無し

新品

9726 内装スポンジフォーム 8007 B Zyklop 電気工事用絶縁ラチェットセット1、9.5mm



05150116001		
+	8007 B VDE	1x 3/8"x222,0
+	410 i VDE B	1x 3/8"x130
+	8790 B VDE	1x 6,0x46,0; 1x 7,0x46,0; 1x 8,0x46,0; 1x 9,0x46,0; 1x 10,0x46,0; 1x 11,0x46,0; 1x 12,0x46,0; 1x 13,0x46,0; 1x 14,0x46,0; 1x 15,0x46,0; 1x 16,0x46,0; 1x 17,0x46,0; 1x 18,0x46,0; 1x 19,0x46,0
+	8767 B VDE HF	1x TX 20x55,0; 1x TX 25x55,0; 1x TX 27x55,0; 1x TX 30x55,0; 1x TX 40x55,0; 1x TX 45x59,0
+	8740 B VDE HF	1x 4,0x55,0; 1x 5,0x55,0; 1x 6,0x55,0; 1x 8,0x59,0
+	8794 SB VDE	1x 3/8"x91,0
+	8794 LB VDE	1x 3/8"x166,0
	9826	1x 344,0x30,0x392,0

新品

9734 内装スポンジフォーム 6004 Joker 電気工事用絶縁自動調整モンキーラチェットレンチセット1



05150124001		
	6004 Joker VDE XS	1x 7-10 (1/4"-3/8")x119
	6004 Joker VDE S	1x 10-13 (7/16"-1/2")x155
	6004 Joker VDE M	1x 13-16 (1/2"-5/8")x190
	6004 Joker VDE L	1x 16-19 (5/8"-3/4")x226
	9834	1x 172,0x30,0x392,0

注意：内装スポンジフォームは、旧モデルのツールのトレー05501051001には適合しない。

新品

9751 内装スポンジフォーム Kraftform Kompakt 電気工事用絶縁セット1

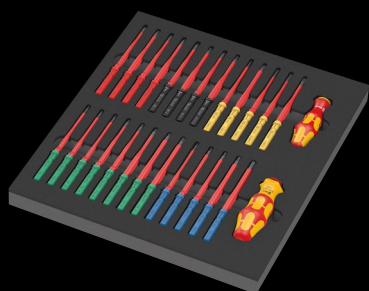

05150151001		
●	837 i RA	1x 9x115
●	817 VDE	1x 9x98
⊕	Kraftform Kompakt VDE 62 iS Take it easy	1x PH 1x157; 1x PH 2x157
⊕	Kraftform Kompakt VDE 65 iS Take it easy	1x PZ 1x157; 1x PZ 2x157
⊕	Kraftform Kompakt VDE 62 iS PH/S Take it easy	1x # 1x157; 1x # 2x157
⊕	Kraftform Kompakt VDE 65 iS PZ/S Take it easy	1x # 1x157; 1x # 2x157
⊕	Kraftform Kompakt VDE 67 i Take it easy	1x TX 8x157; 1x TX 9x157; 1x TX 10x157; 1x TX 27x157; 1x TX 30x157
⊕	Kraftform Kompakt VDE 67 iS Take it easy	1x TX 15x157; 1x TX 20x157; 1x TX 25x157
○	Kraftform Kompakt VDE 64 i Take it easy	1x 2,5x157; 1x 3,0x157; 1x 4,0x157; 1x 5,0x157; 1x 6,0x157
⊖	Kraftform Kompakt VDE 60 iS Take it easy	1x 0,6x3,5x157; 1x 0,8x4,0x157; 1x 1,0x5,5x157
⊖	Kraftform Kompakt VDE 60 i Take it easy	1x 0,4x2,5x157; 1x 1,2x6,5x157
	9851	1x 344,0x30,0x392,0

新品

9724 内装スポンジフォーム 8010 B Zyklop コンフォートラチェットセット1、9.5mm



05150114001		
○	8010 B	1x 3/8"x230,0
●	8790 B Impaktor	1x 8,0x30,0; 1x 10,0x30,0; 1x 11,0x30,0; 1x 12,0x30,0; 1x 13,0x30,0; 1x 14,0x30,0; 1x 15,0x30,0; 1x 16,0x30,0; 1x 17,0x30,0; 1x 18,0x30,0; 1x 19,0x30,0; 1x 21,0x32,0; 1x 22,0x32,0; 1x 24,0x32,0
●○	8798 B	1x 3/8"x152,4
	9824	1x 172,0x30,0x392,0

新品

9725 内装スポンジフォーム 8790 C Zyklop Impaktor Deep ソケットセット1、12.7mm

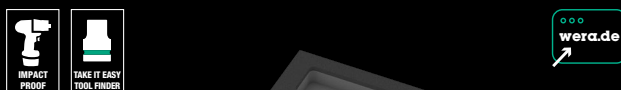

05150115001		
●	8790 C Impaktor Deep	1x 13,0x83,0; 1x 14,0x83,0; 1x 15,0x83,0; 1x 16,0x83,0; 1x 17,0x83,0; 1x 18,0x83,0; 1x 19,0x83,0; 1x 21,0x83,0; 1x 22,0x83,0; 1x 24,0x83,0; 1x 27,0x83,0
	9825	1x 172,0x30,0x392,0

新品

9733 内装スポンジフォーム 6001 Joker コンビネーションラチェットレンチ レバー式 セット1

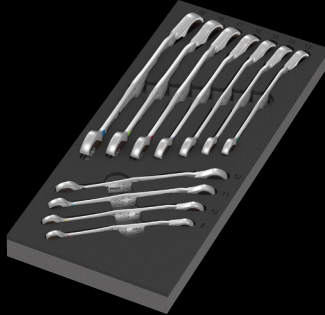

05150123001	
6001 Joker Switch	1x 8x144; 1x 10x159; 1x 11x165; 1x 12x171; 1x 13x179; 1x 14x187; 1x 15x199; 1x 16x213; 1x 17x225; 1x 18x234; 1x 19x246
9833	1x 172,0x30,0x392,0

新品

9784 内装スポンジフォーム KNIPEX 電気工事用絶縁プライヤーセット1



05150184001	
KNIPEX ダイアゴナルストリッパー 70 06 160	
	クニベックスラジオペンチ、ブレード付き (ストークブレイクプライヤー) 26 16 200
	KNIPEX ニードルノーズコンビネーションプライヤー 08 26 185
9884	1x 172,0x30,0x392,0

新品

9752 内装スポンジフォーム Krafftform Kompakt ラチェットセット1



1/4"

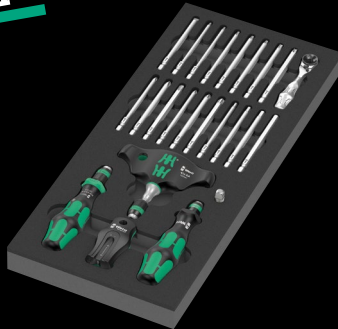

05150152001	
838 RA-R M	1x 1/4"x123,5
416 RA	1x 1/4"x45
816 R	1x 1/4"x119
8001 A	1x 1/4"x87,0
851/4 Z	1x PH 1x89; 1x PH 2x89; 1x PH 3x89 ¹⁾
855/4 Z	1x PZ 1x89; 1x PZ 2x89; 1x PZ 3x89 ¹⁾
867/4 Z TORX®	1x TX 10x89; 1x TX 15x89; 1x TX 20x89; 1x TX 25x89; 1x TX 27x89; 1x TX 30x89; 1x TX 40x89
840/4 Z	1x 3,0x89; 1x 4,0x89; 1x 5,0x89; 1x 6,0x89 ¹⁾
800/4 Z	1x 1,0x5,5x89
870/1	1x 1/4"x25 ²⁾
9500	1x 64,6
9852	1x 172,0x30,0x392,0

¹⁾ 六角ブレード

²⁾ フリクションボール;手動ナットスピナーソケット用

9710 内装スポンジフォーム ドライバー セット1

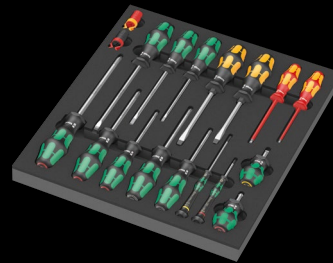

05150101001	
932 A	1x 1,0x5,5x100; 1x 1,2x7,0x125
350 PH	1x PH 1x80; 1x PH 2x100; 1x PH 3x150
350 PH Stubby	1x PH 2x25
355 PZ	1x PZ 1x80; 1x PZ 2x100
335	1x 0,8x4,0x100; 1x 1,0x5,5x125
334	1x 1,2x6,5x150
335 Stubby	1x 1,0x5,5x24,5
2050 Micro	1x PH 0x40 ¹⁾
2035 Micro	1x 0,40x2,5x80
160 i VDE	1x 0,4x2,5x80 ²⁾ ; 1x 0,6x3,5x100 ²⁾
1441	1x 4,5-6,0x41,0
1442	1x 6,0-8,5x41,0
9810	1x 344,0x30,0x392,0

¹⁾ JCS 0 (日本カメラ工業規格)に沿ってサイズ0を調整

²⁾ レーザーチップ無し

9711 内装スポンジフォーム 電気工事用絶縁ドライバーセット 1

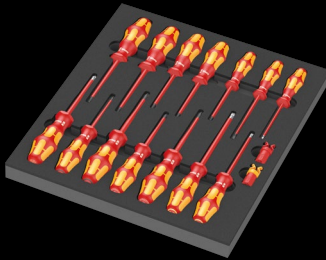

05150102001	
+	162 iS PH VDE 1x PH 1x80; 1x PH 2x100
+	165 iS PZ VDE 1x PZ 1x80; 1x PZ 2x100
+	165 i PZ/S VDE 1x # 2x100
-	160 i VDE 1x 0,4x2,5x80 ¹⁾ ; 1x 0,8x4,0x100; 1x 1,0x5,5x125
-	160 iS VDE 1x 0,6x3,5x100
+	167 i TORX® VDE 1x TX 10x80; 1x TX 15x80; 1x TX 20x80; 1x TX 25x100; 1x TX 30x100
	1440 1x 4,5-6,0x41,0
	1442 1x 6,0-8,5x41,0
	9811 1x 344,0x30,0x392,0

¹⁾ レーザーチップ無し

9713 内装スポンジフォーム 六角ドライバーセット 1

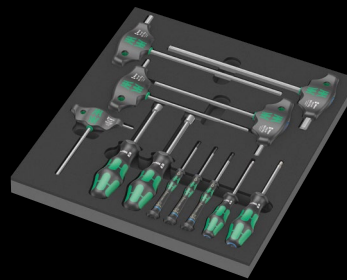

05150104001	
○	354 1x 3,0x75; 1x 4,0x75
○	2054 Micro 1x 1,5x60; 1x 2x60; 1x 2,5x60
○	454 HF 1x 4x100; 1x 5x100; 1x 6x150; 1x 8x200; 1x 10x200
●	395 H0 1x 10,0x90; 1x 13,0x90
	9813 1x 344,0x30,0x392,0

9720 内装スポンジフォーム 8000 A Zyklus 6.35mm ラチェットセット 1



9712 内装スポンジフォーム トルクスドライバー-HF セット 1

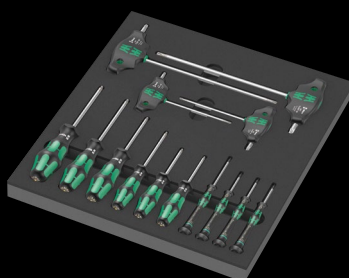

05150103001	
+	367 TORX® HF 1x TX 8x60; 1x TX 9x60; 1x TX 10x80; 1x TX 15x80; 1x TX 20x100; 1x TX 25x100
+	2067 TORX® HF 1x TX 4x40; 1x TX 5x40; 1x TX 6x40; 1x TX 7x60
+	467 TORX® HF 1x TX 20x100; 1x TX 25x100; 1x TX 30x200; 1x TX 40x200
	9812 1x 344,0x30,0x392,0

05150110001	
○	8000 A 1x 1/4"x152,0
●○	8794 LA 1x 1/4"x150,0
●○	8794 SA 1x 1/4"x75,0
●○	8795 A 1x 1/4"x35,5
●○	8794 A 1x 1/4"x56,0
●	8790 HMA 1x 4,0x23,0; 1x 4,5x23,0; 1x 5,0x23,0; 1x 5,5x23,0; 1x 6,0x23,0; 1x 7,0x23,0; 1x 8,0x23,0; 1x 9,0x23,0; 1x 10,0x23,0; 1x 11,0x23,0; 1x 12,0x23,0; 1x 13,0x23,0; 1x 14,0x23,0; 1x 15,0x23,0
+	8767 A HF 1x TX 8x28,0; 1x TX 9x28,0; 1x TX 10x28,0; 1x TX 15x28,0; 1x TX 20x28,0; 1x TX 25x28,0; 1x TX 27x28,0; 1x TX 30x28,0; 1x TX 40x28,0
○	8740 A HF 1x 3,0x28,0; 1x 4,0x28,0; 1x 4,0x100,0; 1x 5,0x28,0; 1x 5,0x100,0; 1x 6,0x28,0; 1x 6,0x100,0; 1x 8,0x28,0; 1x 8,0x100,0
	9820 1x 172,0x30,0x392,0

9721 内装スポンジフォーム 8000 B Zyklop 9.5mm ラ チェットセット 1



3/8"

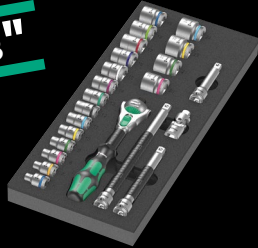

05150111001		
○	8000 B	1x 3/8"x199,0
●○	8794 SB	1x 3/8"x125,0
●○	8794 LB	1x 3/8"x200,0
●○	8795 B	1x 3/8"x50,0
●○	8794 B	1x 3/8"x76,0
●	8790 HMB	1x 6,0x29,0; 1x 7,0x29,0; 1x 8,0x29,0; 1x 9,0x29,0; 1x 10,0x29,0; 1x 11,0x29,0; 1x 12,0x29,0; 1x 13,0x29,0; 1x 14,0x29,0; 1x 15,0x29,0; 1x 16,0x30,0; 1x 17,0x30,0; 1x 18,0x30,0; 1x 19,0x30,0; 1x 20,0x30,0; 1x 21,0x30,0; 1x 22,0x30,0; 1x 24,0x32,0
	9821	1x 172,0x30,0x392,0

9723 内装スポンジフォーム Zyklop B 9.5mm ビット ソケットセット 1



3/8"



05150113001		
●●	8784 B1	1x 1/4"x3/8"x44,0
⊗	8767 B HF	1x TX 15x35,0; 1x TX 20x35,0; 1x TX 25x35,0; 1x TX 25x107,0; 1x TX 27x35,0; 1x TX 27x107,0; 1x TX 30x35,0; 1x TX 30x107,0; 1x TX 40x35,0; 1x TX 40x107,0
○	8740 B HF	1x 4,0x35,0; 1x 4,0x107,0; 1x 5,0x35,0; 1x 5,0x107,0; 1x 6,0x35,0; 1x 6,0x107,0; 1x 7,0x38,5; 1x 8,0x38,5; 1x 8,0x100,0; 1x 10,0x38,5; 1x 10,0x100,0
	9823	1x 172,0x30,0x392,0

9722 内装スポンジフォーム 8000 C Zyklop 12.7mm ラ チェットセット 1



1/2"



05150112001		
○	8000 C	1x 1/2"x277,0
●○	8794 LC	1x 1/2"x250,0
●○	8794 SC	1x 1/2"x125,0
●○	8795 C	1x 1/2"x69,0
●○	8794 C	1x 1/2"x52,0
●	8790 HMC	1x 10,0x37,0; 1x 11,0x37,0; 1x 12,0x37,0; 1x 13,0x37,0; 1x 14,0x37,0; 1x 15,0x37,0; 1x 16,0x37,0; 1x 17,0x37,0; 1x 18,0x37,0; 1x 19,0x37,0; 1x 20,0x37,0; 1x 21,0x37,0; 1x 22,0x37,0; 1x 24,0x37,0; 1x 27,0x40,0; 1x 30,0x42,0; 1x 32,0x42,0
○	8740 C HF	1x 4,0x60,0; 1x 4,0x140,0; 1x 5,0x60,0; 1x 5,0x140,0; 1x 6,0x60,0; 1x 6,0x140,0; 1x 7,0x60,0; 1x 8,0x60,0; 1x 10,0x60,0
	9822	1x 344,0x30,0x392,0

9730 内装スポンジフォーム 6000 Joker セット 1



05150120001		
	6000 Joker	1x 8x144; 1x 10x159; 1x 11x165; 1x 12x170,7; 1x 13x177; 1x 14x188; 1x 15x200; 1x 16x212; 1x 17x224; 1x 18x235; 1x 19x246
	9830	1x 172,0x30,0x392,0

9731 内装スポンジフォーム 6003 Joker セット 1



05150121001	6003 Joker レンチ 1x 6x105; 1x 7x110; 1x 8x115; 1x 9x120; 1x 10x125; 1x 11x135; 1x 12x148; 1x 13x160; 1x 14x167; 1x 15x174; 1x 16x182; 1x 17x190; 1x 18x210; 1x 19x230,0; 1x 20x230,0; 1x 21x260; 1x 22x260; 1x 24x280
	ボトルオープナー 1x 148
9831	1x 344,0x30,0x392,0

9732 内装スポンジフォーム 6004 Joker セット 1



05150122001	6004 Joker XS 1x 7-10 (1/4"-3/8")x117
	6004 Joker S 1x 10-13 (7/16"-1/2")x154
	6004 Joker M 1x 13-16 (1/2"-5/8")x188
	6004 Joker L 1x 16-19 (5/8"-3/4")x224
	6004 Joker XL 1x 19-24x (3/4"-15/16")x256
9832	1x 172,0x30,0x392,0

9740 内装スポンジフォーム L型レンチ セット 1

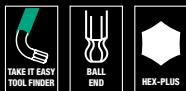

05150140001	950 SPKL Multicolour 1x 1.5x90; 1x 2.0x101; 1x 2.5x112; 1x 3.0x123; 1x 4.0x137; 1x 5.0x154; 1x 6.0x172; 1x 8.0x195; 1x 10.0x224
	967/9 TX XL Multicolour 1 967 SXL TORX® Multicolour 1x TX 8x90; 1x TX 9x101; 1x TX 10x112
	967 SPKXL TORX® Multicolour 1x TX 15x123; 1x TX 20x137; 1x TX 25x154; 1x TX 27x172; 1x TX 30x195; 1x TX 40x224
	9500 1x 64,6
	STABILA® ポケット巻尺 BM 100、3 m、item 19570 1x 3000,0
	9840 1x 172,0x30,0x392,0

9750 内装スポンジフォーム Kraftform Kompakt と Tool-Check PLUS セット 1



05150150001	1x Tool-Check PLUS
	8001 A 1x 1/4"x87.0
	813 1x 1/4"x78
	889/4/1 K 1x 1/4"x50
	870/1 1x 1/4"x25 1)
	8790 HMA 1x 5.5x23.0; 1x 6.0x23.0; 1x 7.0x23.0; 1x 8.0x23.0; 1x 10.0x23.0; 1x 12.0x23.0; 1x 13.0x23.0
	851/1 TZ 2x PH 1x25; 3x PH 2x25; 1x PH 3x25
	855/1 TH 1x PZ 1x25; 3x PZ 2x25; 1x PZ 3x25
	867/1 TZ TORX® 1x TX 10x25; 1x TX 15x25; 1x TX 20x25; 1x TX 25x25; 1x TX 30x25; 1x TX 40x25
	867/1 Z TORX® B0 1x TX 10x25; 1x TX 15x25; 1x TX 20x25; 1x TX 25x25; 1x TX 30x25
	840/1 Z 1x 3.0x25; 1x 4.0x25; 1x 5.0x25; 1x 6.0x25; 1x 8.0x25
	800/1 TZ 1x 1.0x5.5x25
	1x Kraftform Kompakt 60
	816 R 1x 1/4"x119
	851/4 Z 1x PH 1x89; 1x PH 2x89; 1x PH 3x89 2)
	855/4 Z 1x PZ 1x89; 1x PZ 2x89; 1x PZ 3x89 2)
	867/4 Z TORX® B0 1x TX 10x89; 1x TX 15x89; 1x TX 20x89; 1x TX 25x89; 1x TX 30x89
	800/4 Z 1x 1.0x5.5x89
	840/4 Z 1x 3.0x89; 1x 4.0x89; 1x 5.0x89; 1x 6.0x89 2)
	ストリップ交換可70 1x 50.0x70.0
	1x 393 S
	8001 A 1x 1/4"x173,5
	1x 9850 1x 172,0x30,0x392,0

1) フリクションボール; 手動ナットスピナーソケット用
2) 六角ブレード

9780 内装スポンジフォーム KNIPEX プライヤーセット 1



05150180001	
KNIPEX コン ビネーション プライヤー ー 03 05 180	1x 180
KNIPEX Cobra® ハイ テクウォー ターポンプ プライヤー 87 05 250	1x 250
KNIPEX ハイ レバレッジ 電気工事用 ニッパー 74 05 160	1x 160
9880	1x 172,0x30,0x392,0

9782 内装スポンジフォーム ハンマーセット 1

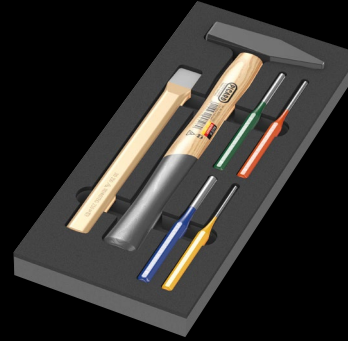

05150182001	
PICARD® リベ ットハンマ ー 500g、 0000101-500	1x 500,0
RENNSTEIG ピ ンパンチ 1x 452 003 6 RC, 3,0x150; 1x 452 004 6 RC, 4,0x150; 1x 452 006 6 RC, 6,0x150; 1x 452 008 6 RC, 8,0x150	
RENNSTEIG 平 タガネ 310 250 1	1x 25,0x13,0x23,0
9882	1x 172,0x30,0x392,0

9781 内装スポンジフォーム KNIPEX プライヤーセット 2

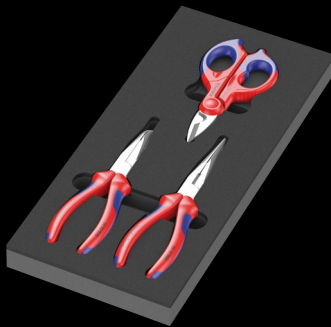

05150181001	
KNIPEX 平丸 型カッティ ングプライ ヤー(くち ばし型プラ イヤー) 26 15 200	1x 200
KNIPEXメカ ニック用プ ライヤー 38 25 200	1x 200
KNIPEX 電気 工事用ニッ パー 95 05 155	1x 155
9881	1x 172,0x30,0x392,0

9783 内装スポンジフォーム PFERD やすりセット 1

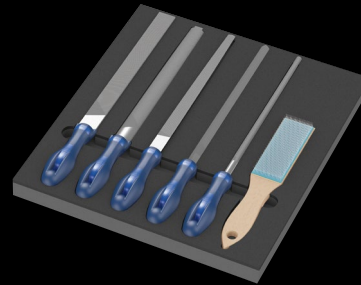

05150183001	
PFERD やす りスクエ ア PF1142 250 H2	1x 250
PFERD やす り半円形 1152SP 250 H2	1x 250
PFERD やす りラウンド 1162 250 H2	1x 250
PFERD やす りハンド タイプ 1112 250 H2	1x 250
PFERD やす りスリース クエア 1132 250 H2	1x 250
PFERD スク ラッチブラ シ HBF 鋼線 00.15	1x 232
9883	1x 344,0x30,0x392,0

当社は、本カタログに記載されている製品の特徴、種類及び履行に関して、予告なしで変更する権利があります。印刷のエラーやミスに対する責任は負いません。



Wera Tools Japan G.K.
Japan
Tel.: +81-3-3915-2555
E-Mail: frank.yang@wera.de

Wera Werkzeuge GmbH
Korzarter Straße 21-25
D-42349 Wuppertal

Phone: +49 (0)202/40 45-0
E-Mail: info@wera.de
www.wera.de