

# 워크샵 트롤리 및 폼 인서트

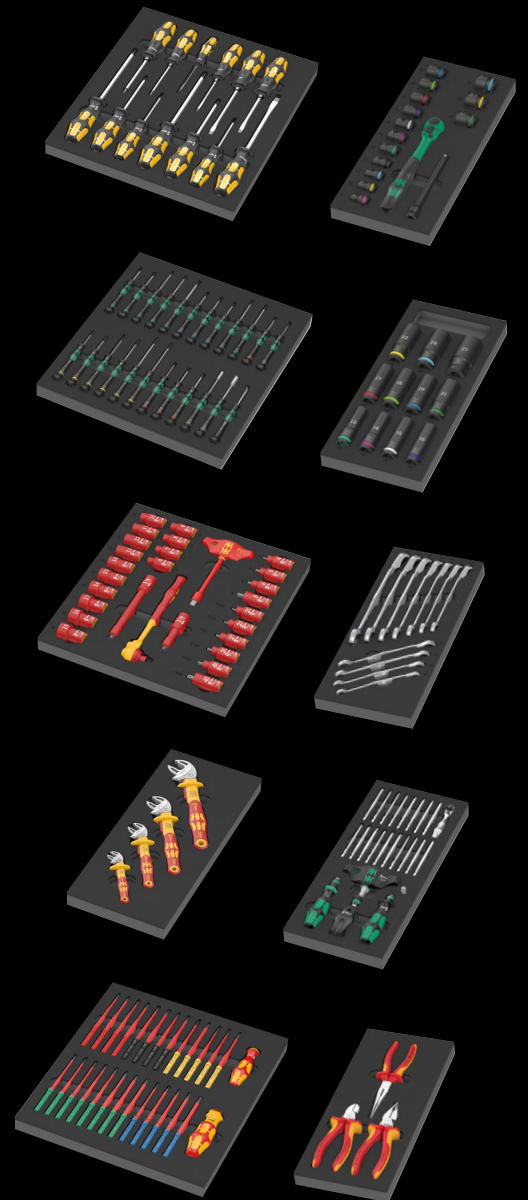

## 세련된 전면 디자인에 충분한 장비가 갖춰진 최고급 품질 워크샵 트롤리.

- **Tool Rebel** 디자인의 독점 워크샵 트롤리
- 이중 벽 디자인 덕분에 매우 견고한 디자인
- 드로워 7개(플랫 5개, 하이 2개) - 플랫 드로워 2개에는 폼 인서트와 공구가 장착되어 있음
- 크기 플랫 드로워(너비 x 높이 x 깊이): **522 x 81 x 398mm**
- 하이 드로워 크기(너비 x 높이 x 깊이): **522 x 166 x 398mm**
- 볼 베어링 텔레스코픽 슬라이드가 장착된 **100%** 드로워 풀아웃, 자동 닫힘
- 모든 드로워는 정교하고 개별적으로 레이아웃됨
- 드로워 스톱 덕분에 기울어져 넘어갈 위험 최소화 - 드로워 하나만 열려 있을 수 있음, 여러 드로워의 동시 풀아웃 없음
- 화학기상이 없는 견고한 고품질 폼 인서트
- 폼 인서트에서 공구를 최대한 제거할 수 있는 데 가장 적합함





9700 Tool Rebel 워크샵 트롤리 1



다음 품 인서트가 포함됩니다.



9710

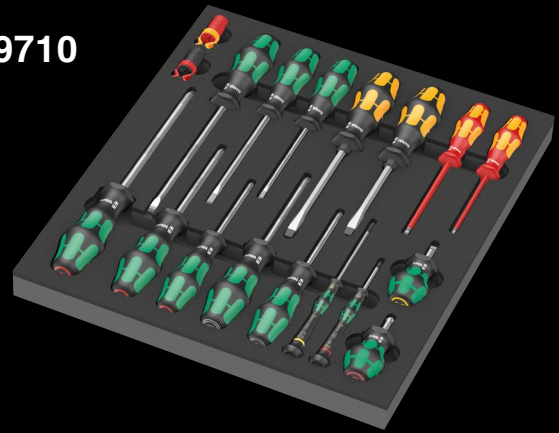

9720

1/4"

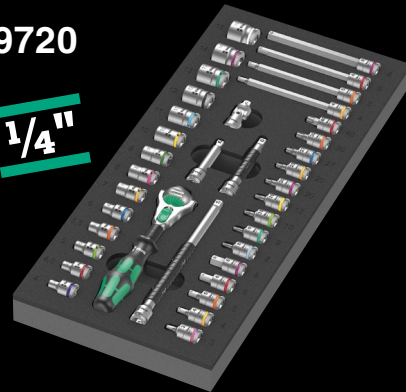

9731



9740



Tool Rebel 디자인의 독점 워크샵 트롤리 5개의 플랫폼 드로워 및 2개의 하이드로워로 이동성을 갖춘 충분한 공구와 재질 정리 공간을 보장합니다. 이중 벽면 디자인과 전체 바디가 완전히 용접된 구조로 매우 견고한 디자인을 자랑합니다. 워크샵에서의 일상 작업에 적합합니다. 다음 4개의 Wera 품 인서트가 장착되어 있습니다. 9710 품 인서트 스크루드라이버 세트 1, 9720 품 인서트 8000 A Zyklus 래치 세트 1, 9731 품 인서트 6003 Joker 링 스패너 세트 1, 9740 품 인서트 L-키 세트 1.

05150130001 1x 9700 Tool Rebel 워크샵 트롤리 1

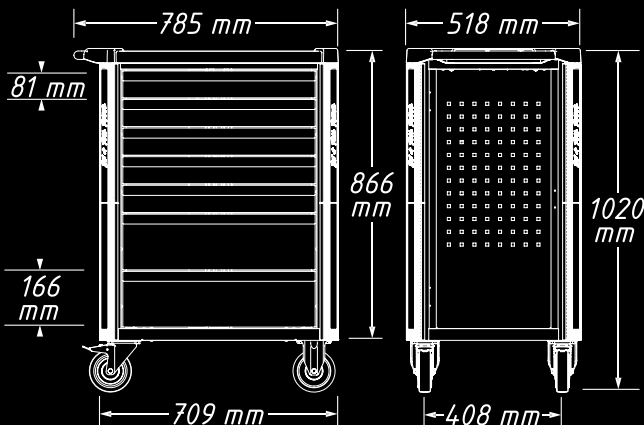

## 새로운

### 9714 폼 인서트 치즐드라이버 스크루드라이버 세트 1



05150105001		
+	917 SPH	1x PH 1x80; 1x PH 2x100; 1x PH 3x150
+	918 SPZ	1x PZ 1x80; 1x PZ 2x100; 1x PZ 3x150
-	932 A	1x 0,6x3,5x80 <sup>1)</sup> ; 1x 0,8x4,5x90; 1x 1,0x5,5x100; 1x 1,2x7,0x125; 1x 1,6x9,0x150
+	977 TORX®	1x TX 20x90; 1x TX 25x100
	9814	1x 344,0x30,0x392,0

<sup>1)</sup> 캡에 연결된 브레이드 무(없음)

## 새로운

### 9715 폼 인서트 Wera Kraftform 마이크로 스크루드라이버 세트 1

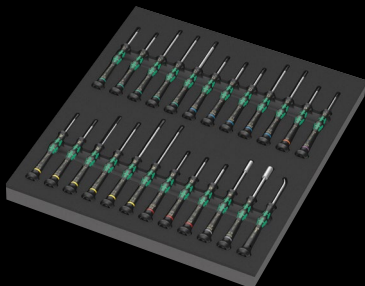

05150106001		
+	2050 Micro	1x PH 000x40 <sup>1) 2)</sup> ; 1x PH 00x40 <sup>1) 2)</sup> ; 1x PH 0x40 <sup>3)</sup>
+	2067 TORX® HF	1x TX 5x40; 1x TX 6x40; 1x TX 7x60; 1x TX 8x60; 1x TX 10x60
+	2067 TORX PLUS® IPR Micro	1x 1 IPRx40 <sup>4)</sup>
+	2072 Micro	1x mx40
○	2054 Micro	1x 0,7x40; 1x 0,9x40; 1x 1,3x40; 1x 1,5x60; 1x 2x60
-	2035 Micro	1x 0,23x1,5x40; 1x 0,30x1,8x60; 1x 0,35x2,5x40; 1x 0,40x2,0x60; 1x 0,40x2,5x80; 1x 0,50x3,0x80
●	2069 Micro	1x 4,0x60; 1x 5,5x60
●	1429	1x 1,0x3,5x50
	9815	1x 344,0x30,0x392,0

<sup>1)</sup> 아시아형 필립스 나사에 맞게 최적화

<sup>2)</sup> 출력측상 블레이드(날)가 명목상 10mm 돌아감

<sup>3)</sup> JCS 0 (일본 카메라 산업 표준)에 따라 변경된 사이즈 0

<sup>4)</sup> 천공 미포함

주의: 이 폼 인서트는 워크샵 트롤리 이전 모델 05501051001에는 맞지 않습니다.

## 새로운

### 9726 폼 인서트 8007 B VDE Zyklop VDE 래칫 세트 1, 3/8"

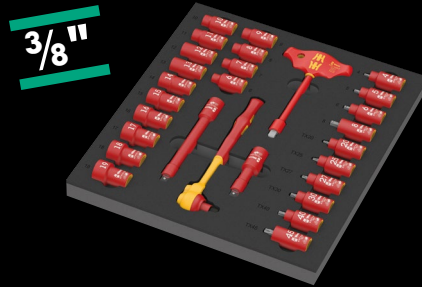

05150116001		
○	8007 B VDE	1x 3/8"x222,0
○	410 i VDE B	1x 3/8"x130
●	8790 B VDE	1x 6,0x46,0; 1x 7,0x46,0; 1x 8,0x46,0; 1x 9,0x46,0; 1x 10,0x46,0; 1x 11,0x46,0; 1x 12,0x46,0; 1x 13,0x46,0; 1x 14,0x46,0; 1x 15,0x46,0; 1x 16,0x46,0; 1x 17,0x46,0; 1x 18,0x46,0; 1x 19,0x46,0
+	8767 B VDE HF	1x TX 20x55,0; 1x TX 25x55,0; 1x TX 27x55,0; 1x TX 30x55,0; 1x TX 40x55,0; 1x TX 45x59,0
○	8740 B VDE HF	1x 4,0x55,0; 1x 5,0x55,0; 1x 6,0x55,0; 1x 8,0x59,0
○	8794 SB VDE	1x 3/8"x91,0
○	8794 LB VDE	1x 3/8"x166,0
	9826	1x 344,0x30,0x392,0

## 새로운

### 9734 폼 인서트 6004 Joker VDE 세트 1



05150124001		
	6004 Joker VDE XS	1x 7-10 (1/4"-3/8")x119
	6004 Joker VDE S	1x 10-13 (7/16"-1/2")x155
	6004 Joker VDE M	1x 13-16 (1/2"-5/8")x190
	6004 Joker VDE L	1x 16-19 (5/8"-3/4")x226
	9834	1x 172,0x30,0x392,0

## 새로운

### 9751 폼 인서트 Kraftform Kompakt VDE 세트 1

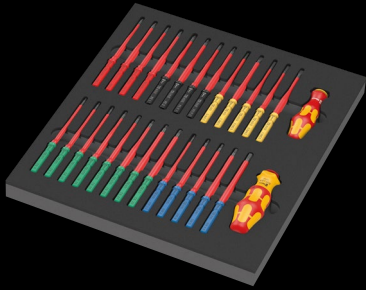

05150151001		
●	837 i RA	1x 9x115
●	817 VDE	1x 9x98
⊕	Kraftform Kompakt VDE 62 iS Take it easy	1x PH 1x157; 1x PH 2x157
⊕	Kraftform Kompakt VDE 65 iS Take it easy	1x PZ 1x157; 1x PZ 2x157
⊕	Kraftform Kompakt VDE 62 iS PH/S Take it easy	1x # 1x157; 1x # 2x157
⊕	Kraftform Kompakt VDE 65 iS PZ/S Take it easy	1x # 1x157; 1x # 2x157
⊕	Kraftform Kompakt VDE 67 i Take it easy	1x TX 8x157; 1x TX 9x157; 1x TX 10x157; 1x TX 27x157; 1x TX 30x157
⊕	Kraftform Kompakt VDE 67 iS Take it easy	1x TX 15x157; 1x TX 20x157; 1x TX 25x157
○	Kraftform Kompakt VDE 64 i Take it easy	1x 2,5x157; 1x 3,0x157; 1x 4,0x157; 1x 5,0x157; 1x 6,0x157
⊖	Kraftform Kompakt VDE 60 iS Take it easy	1x 0,6x3,5x157; 1x 0,8x4,0x157; 1x 1,0x5,5x157
⊖	Kraftform Kompakt VDE 60 i Take it easy	1x 0,4x2,5x157; 1x 1,2x6,5x157
	9851	1x 344,0x30,0x392,0

## 새로운

### 9724 폼 인서트 8010 B Zyklop Comfort 래칫 세트 1, 3/8"



3/8"



05150114001		
○	8010 B	1x 3/8"x230,0
●	8790 B Impaktor	1x 8,0x30,0; 1x 10,0x30,0; 1x 11,0x30,0; 1x 12,0x30,0; 1x 13,0x30,0; 1x 14,0x30,0; 1x 15,0x30,0; 1x 16,0x30,0; 1x 17,0x30,0; 1x 18,0x30,0; 1x 19,0x30,0; 1x 21,0x32,0; 1x 22,0x32,0; 1x 24,0x32,0
●○	8798 B	1x 3/8"x152,4
	9824	1x 172,0x30,0x392,0

## 새로운

### 9725 폼 인서트 Zyklop C, 1/2", Impaktor Deep 소켓 세트 1



05150115001		
●	8790 C Impaktor Deep	1x 13,0x83,0; 1x 14,0x83,0; 1x 15,0x83,0; 1x 16,0x83,0; 1x 17,0x83,0; 1x 18,0x83,0; 1x 19,0x83,0; 1x 21,0x83,0; 1x 22,0x83,0; 1x 24,0x83,0; 1x 27,0x83,0
	9825	1x 172,0x30,0x392,0

## 새로운

### 9733 폼 인서트 6001 Joker 스위치 세트 1



05150123001	
6001 Joker Switch	1x 8x144; 1x 10x159; 1x 11x165; 1x 12x171; 1x 13x179; 1x 14x187; 1x 15x199; 1x 16x213; 1x 17x225; 1x 18x234; 1x 19x246
9833	1x 172,0x30,0x392,0

## 새로운

### 9784 폼 인서트 KNIPEX 펜치 VDE 세트 1

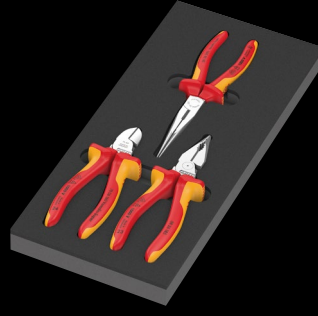

05150184001	
KNIPEX 대각선 스트리퍼 70 06 160	
KNIPEX(크니펙스) 스나이프 노즈 플라이어(황새 부리 플라이어) 26 16 200	
KNIPEX 니들 노즈 컴비네이션 펜치 08 26 185	
9884	1x 172,0x30,0x392,0

## 새로운

### 9752 폼 인서트 Kraftform Kompakt 래칫 세트 1



1/4"



05150152001	
838 RA-R M	1x 1/4"x123,5
416 RA	1x 1/4"x45
816 R	1x 1/4"x119
8001 A	1x 1/4"x87,0
851/4 Z	1x PH 1x89; 1x PH 2x89; 1x PH 3x89 <sup>1)</sup>
855/4 Z	1x PZ 1x89; 1x PZ 2x89; 1x PZ 3x89 <sup>1)</sup>
867/4 Z TORX®	1x TX 10x89; 1x TX 15x89; 1x TX 20x89; 1x TX 25x89; 1x TX 27x89; 1x TX 30x89; 1x TX 40x89
840/4 Z	1x 3,0x89; 1x 4,0x89; 1x 5,0x89; 1x 6,0x89 <sup>1)</sup>
800/4 Z	1x 1,0x5,5x89
870/1	1x 1/4"x25 <sup>2)</sup>
9500	1x 64,6
9852	1x 172,0x30,0x392,0

<sup>1)</sup> 육각형 칼날

<sup>2)</sup> 마찰 감소 볼 장착, 수동 너트 스피너 소켓용

### 9710 폼 인서트 스크루드라이버 세트 1

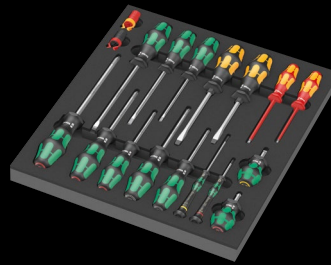

05150101001	
932 A	1x 1,0x5,5x100; 1x 1,2x7,0x125
350 PH	1x PH 1x80; 1x PH 2x100; 1x PH 3x150
350 PH 주먹	1x PH 2x25
355 PZ	1x PZ 1x80; 1x PZ 2x100
335	1x 0,8x4,0x100; 1x 1,0x5,5x125
334	1x 1,2x6,5x150
335 주먹/카 뷰레터 스크 루드라이버	1x 1,0x5,5x24,5
2050 Micro	1x PH 0x40 <sup>1)</sup>
2035	1x 0,40x2,5x80
160 i VDE	1x 0,4x2,5x80 <sup>2)</sup> ; 1x 0,6x3,5x100 <sup>2)</sup>
1441	1x 4,5-6,0x41,0
1442	1x 6,0-8,5x41,0
9810	1x 344,0x30,0x392,0

<sup>1)</sup> JCS 0 (일본 카메라 산업 표준)에 따라 변경된 사이즈 0

<sup>2)</sup> 레이저팁 미포함

## 9711 폼 인서트 VDE 스크루드라이버 세트 1

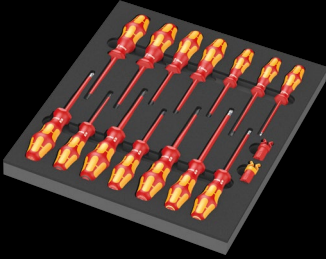

05150102001	
+	162 iS PH VDE 1x PH 1x80; 1x PH 2x100
+	165 iS PZ VDE 1x PZ 1x80; 1x PZ 2x100
+	165 i PZ/S VDE 1x # 2x100
-	160 i VDE 1x 0,4x2,5x80 <sup>1)</sup> ; 1x 0,8x4,0x100; 1x 1,0x5,5x125
-	160 iS VDE 1x 0,6x3,5x100
+	167 i TORX® VDE 1x TX 10x80; 1x TX 15x80; 1x TX 20x80; 1x TX 25x100; 1x TX 30x100
	1440 1x 4,5-6,0x41,0
	1442 1x 6,0-8,5x41,0
	9811 1x 344,0x30,0x392,0

<sup>1)</sup> 레이저팁 미포함

## 9713 폼 인서트 헥스 스크루드라이버 세트 1

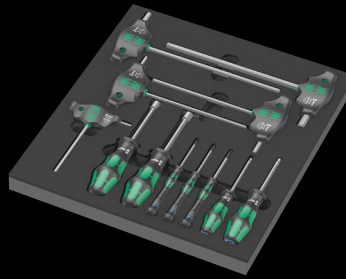

05150104001	
○	354 1x 3,0x75; 1x 4,0x75
○	2054 Micro 1x 1,5x60; 1x 2x60; 1x 2,5x60
○	454 HF 1x 4x100; 1x 5x100; 1x 6x150; 1x 8x200; 1x 10x200
●	395 H0 1x 10,0x90; 1x 13,0x90
	9813 1x 344,0x30,0x392,0

## 9720 폼 인서트 8000 A Zyklus 1/4" 래칫 세트 1



## 9712 폼 인서트 TORX® HF 스크루드라이버 세트 1

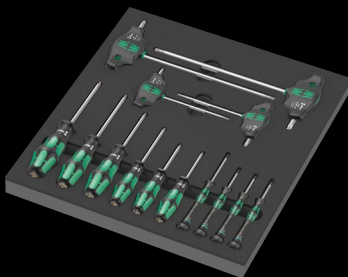

05150103001	
+	367 TORX® HF 1x TX 8x60; 1x TX 9x60; 1x TX 10x80; 1x TX 15x80; 1x TX 20x100; 1x TX 25x100
+	2067 TORX® HF 1x TX 4x40; 1x TX 5x40; 1x TX 6x40; 1x TX 7x60
+	467 TORX® HF 1x TX 20x100; 1x TX 25x100; 1x TX 30x200; 1x TX 40x200
	9812 1x 344,0x30,0x392,0

05150110001	
○	8000 A 1x 1/4"x152,0
●○	8794 LA 1x 1/4"x150,0
●○	8794 SA 1x 1/4"x75,0
●○	8795 A 1x 1/4"x35,5
●○	8794 A 1x 1/4"x56,0
●	8790 HMA 1x 4,0x23,0; 1x 4,5x23,0; 1x 5,0x23,0; 1x 5,5x23,0; 1x 6,0x23,0; 1x 7,0x23,0; 1x 8,0x23,0; 1x 9,0x23,0; 1x 10,0x23,0; 1x 11,0x23,0; 1x 12,0x23,0; 1x 13,0x23,0; 1x 14,0x23,0; 1x 15,0x23,0
+	8767 A HF 1x TX 8x28,0; 1x TX 9x28,0; 1x TX 10x28,0; 1x TX 15x28,0; 1x TX 20x28,0; 1x TX 25x28,0; 1x TX 27x28,0; 1x TX 30x28,0; 1x TX 40x28,0
○	8740 A HF 1x 3,0x28,0; 1x 4,0x28,0; 1x 4,0x100,0; 1x 5,0x28,0; 1x 5,0x100,0; 1x 6,0x28,0; 1x 6,0x100,0; 1x 8,0x28,0; 1x 8,0x100,0
	9820 1x 172,0x30,0x392,0



### 9721 폼 인서트 8000 B Zyklop 3/8" 래칫 세트 1



05150111001		
○	8000 B	1x 3/8"x199,0
●○	8794 SB	1x 3/8"x125,0
●○	8794 LB	1x 3/8"x200,0
●○	8795 B	1x 3/8"x50,0
●○	8794 B	1x 3/8"x76,0
●	8790 HMB	1x 6,0x29,0; 1x 7,0x29,0; 1x 8,0x29,0; 1x 9,0x29,0; 1x 10,0x29,0; 1x 11,0x29,0; 1x 12,0x29,0; 1x 13,0x29,0; 1x 14,0x29,0; 1x 15,0x29,0; 1x 16,0x30,0; 1x 17,0x30,0; 1x 18,0x30,0; 1x 19,0x30,0; 1x 20,0x30,0; 1x 21,0x30,0; 1x 22,0x30,0; 1x 24,0x32,0
	9821	1x 172,0x30,0x392,0

### 9723 폼 인서트 Zyklop B 3/8" 비트 소켓 세트 1



05150113001		
●●	8784 B1	1x 1/4"x3/8"x44,0
⊗	8767 B HF	1x TX 15x35,0; 1x TX 20x35,0; 1x TX 25x35,0; 1x TX 25x107,0; 1x TX 27x35,0; 1x TX 27x107,0; 1x TX 30x35,0; 1x TX 30x107,0; 1x TX 40x35,0; 1x TX 40x107,0
○	8740 B HF	1x 4,0x35,0; 1x 4,0x107,0; 1x 5,0x35,0; 1x 5,0x107,0; 1x 6,0x35,0; 1x 6,0x107,0; 1x 7,0x38,5; 1x 8,0x38,5; 1x 8,0x100,0; 1x 10,0x38,5; 1x 10,0x100,0
	9823	1x 172,0x30,0x392,0

### 9722 폼 인서트 8000 C Zyklop 1/2" 래칫 세트 1



05150112001		
○	8000 C	1x 1/2"x277,0
●○	8794 LC	1x 1/2"x250,0
●○	8794 SC	1x 1/2"x125,0
●○	8795 C	1x 1/2"x69,0
●○	8794 C	1x 1/2"x52,0
●	8790 HMC	1x 10,0x37,0; 1x 11,0x37,0; 1x 12,0x37,0; 1x 13,0x37,0; 1x 14,0x37,0; 1x 15,0x37,0; 1x 16,0x37,0; 1x 17,0x37,0; 1x 18,0x37,0; 1x 19,0x37,0; 1x 20,0x37,0; 1x 21,0x37,0; 1x 22,0x37,0; 1x 24,0x37,0; 1x 27,0x40,0; 1x 30,0x42,0; 1x 32,0x42,0
○	8740 C HF	1x 4,0x60,0; 1x 4,0x140,0; 1x 5,0x60,0; 1x 5,0x140,0; 1x 6,0x60,0; 1x 6,0x140,0; 1x 7,0x60,0; 1x 8,0x60,0; 1x 10,0x60,0
	9822	1x 344,0x30,0x392,0

### 9730 폼 인서트 6000 Joker 세트 1



05150120001		
	6000 Joker	1x 8x144; 1x 10x159; 1x 11x165; 1x 12x170,7; 1x 13x177; 1x 14x188; 1x 15x200; 1x 16x212; 1x 17x224; 1x 18x235; 1x 19x246
	9830	1x 172,0x30,0x392,0

### 9731 폼 인서트 6003 Joker 세트 1



05150121001		
	<b>6003 조커</b>	1x 6x105; 1x 7x110; 1x 8x115; 1x 9x120; 1x 10x125; 1x 11x135; 1x 12x148; 1x 13x160; 1x 14x167; 1x 15x174; 1x 16x182; 1x 17x190; 1x 18x210; 1x 19x230,0; 1x 20x230,0; 1x 21x260; 1x 22x260; 1x 24x280
	<b>병따개</b>	1x 148
	<b>9831</b>	1x 344,0x30,0x392,0

### 9732 폼 인서트 6004 Joker 세트 1



05150122001		
	<b>6004 Joker XS</b>	1x 7-10 (1/4"-3/8")x117
	<b>6004 Joker S</b>	1x 10-13 (7/16"-1/2")x154
	<b>6004 Joker M</b>	1x 13-16 (1/2"-5/8")x188
	<b>6004 Joker L</b>	1x 16-19 (5/8"-3/4")x224
	<b>6004 Joker XL</b>	1x 19-24 (3/4"-15/16")x256
	<b>9832</b>	1x 172,0x30,0x392,0

### 9740 폼 인서트 L-키 세트 1

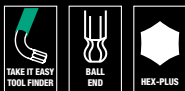

05150140001		
	<b>950/9 Hex-Plus 멀티컬러 1</b>	
	○ <b>950 SPKL 멀티컬러</b>	1x 1.5x90; 1x 2.0x101; 1x 2.5x112; 1x 3.0x123; 1x 4.0x137; 1x 5.0x154; 1x 6.0x172; 1x 8.0x195; 1x 10.0x224
	<b>967/9 TX XL 멀티컬러 1</b>	
	⊗ <b>967 SXL TORX® 멀티컬러</b>	1x TX 8x90; 1x TX 9x101; 1x TX 10x112
	⊗ <b>967 SPKXL TORX® 멀티컬러</b>	1x TX 15x123; 1x TX 20x137; 1x TX 25x154; 1x TX 27x172; 1x TX 30x195; 1x TX 40x224
	<b>9500</b>	1x 64,6
	<b>1x STABILA® 포켓 테이프 측정 BM 100, 3m, 항목 19570</b>	1x 3000,0
	<b>9840</b>	1x 172,0x30,0x392,0

### 9750 폼 인서트 Kraffform Kompakt 및 Tool-Check PLUS 세트 1



05150150001		
	<b>1x 툴체크 PLUS</b>	
	● <b>8001 A</b>	1x 1/4"x87.0
	● <b>813</b>	1x 1/4"x78
	● <b>889/4/1 K</b>	1x 1/4"x50
	○ <b>870/1</b>	1x 1/4"x25 <sup>1)</sup>
	● <b>8790 HMA</b>	1x 5.5x23.0; 1x 6.0x23.0; 1x 7.0x23.0; 1x 8.0x23.0; 1x 10.0x23.0; 1x 12.0x23.0; 1x 13.0x23.0
	⊕ <b>851/1 TZ</b>	2x PH 1x25; 3x PH 2x25; 1x PH 3x25
	⊕ <b>855/1 TH</b>	1x PZ 1x25; 3x PZ 2x25; 1x PZ 3x25
	⊗ <b>867/1 TZ TORX®</b>	1x TX 10x25; 1x TX 15x25; 1x TX 20x25; 1x TX 25x25; 1x TX 30x25; 1x TX 40x25
	⊗ <b>867/1 Z TORX® BO</b>	1x TX 10x25; 1x TX 15x25; 1x TX 20x25; 1x TX 25x25; 1x TX 30x25
	○ <b>840/1 Z</b>	1x 3.0x25; 1x 4.0x25; 1x 5.0x25; 1x 6.0x25; 1x 8.0x25
	● <b>800/1 TZ</b>	1x 1.0x5.5x25
	<b>1x Kraffform Kompakt 60</b>	
	● <b>816 R</b>	1x 1/4"x119
	⊕ <b>851/4 Z</b>	1x PH 1x89; 1x PH 2x89; 1x PH 3x89 <sup>2)</sup>
	⊕ <b>855/4 Z</b>	1x PZ 1x89; 1x PZ 2x89; 1x PZ 3x89 <sup>2)</sup>
	⊗ <b>867/4 Z TORX® BO</b>	1x TX 10x89; 1x TX 15x89; 1x TX 20x89; 1x TX 25x89; 1x TX 30x89
	● <b>800/4 Z</b>	1x 1.0x5.5x89
	○ <b>840/4 Z</b>	1x 3.0x89; 1x 4.0x89; 1x 5.0x89; 1x 6.0x89 <sup>2)</sup>
	<b>벨크로 스트립 70</b>	1x 50.0x70.0
	<b>1x 393 S</b>	
	●	1x 1/4"x173,5
	<b>1x 9850</b>	
		1x 172,0x30,0x392,0

<sup>1)</sup> 마찰 감소 볼 장착; 수동 너트 스피너 소켓용  
<sup>2)</sup> 육각형 칼날

9780 폼 인서트 KNIPEX 펜치 세트 1



05150180001	
KNIPEX 조합 펜치 03 05 180	1x 180
KNIPEX Cobra® 하이 테크 급수 펌 프 펜치 87 05 250	1x 250
KNIPEX 하이 레버리지 대 각선 커터 74 05 160	1x 160
9880	1x 172,0x30,0x392,0

9782 폼 인서트 해머 세트 1

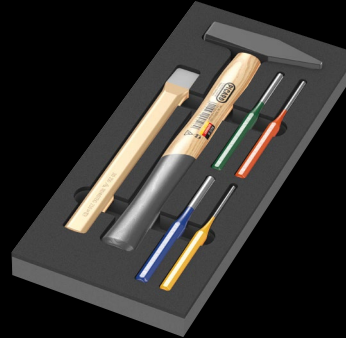

05150182001	
PICARD® 리베 팅 해머 500g, 0000101-500	1x 500,0
Rennsteig 익 스클루시브 핀 펀치	1x 452 003 6 RC, 3,0x150; 1x4520046RC, 4,0x150; 1x4520066RC, 6,0x150; 1x 452 008 6 RC, 8,0x150
RENNSTEIG 플 랫 콜드 치셀 310 250 1	1x 25,0x13,0x23,0
9882	1x 172,0x30,0x392,0

9781 폼 인서트 KNIPEX 펜치 세트 2

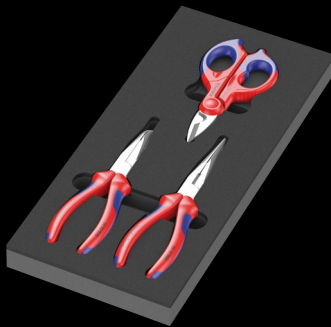

05150181001	
KNIPEX 스나 이프 노즈 컷 팅 펜치(스토 크 비크 펜치) 26 15 200	1x 200
KNIPEX 기계 기사 펜치 38 25 200	1x 200
KNIPEX 전기 기사 시어 95 05 155	1x 155
9881	1x 172,0x30,0x392,0

9783 폼 인서트 PFERD 파일 세트 1

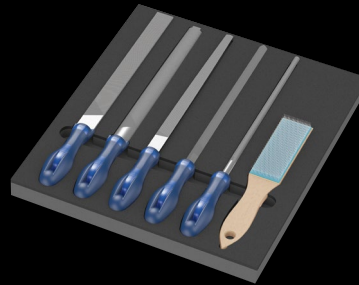

05150183001	
PFERD 기계 운전자 파 일 스퀘어 PF1142 250 H2	1x 250
PFERD 기계 운전자 파 일 반원 포인 티드 1152SP 250 H2	1x 250
PFERD 기계 운전자 파 일 원 1162 250 H2	1x 250
PFERD 기계 운전자 파 일 핸드 1112 250 H2	1x 250
PFERD 기계 운전자 파일 쓰리 스퀘어 1132 250 H2	1x 250
PFERD 스크 래치 브러시 HBF 스틸 와 이어 Ø 0.15	1x 232
9883	1x 344,0x30,0x392,0



Wera Werkzeuge GmbH  
Korzter Straße 21-25  
D-42349 Wuppertal

Phone: +49 (0)2 02/40 45-0  
E-Mail: [info@wera.de](mailto:info@wera.de)  
[www.wera.de](http://www.wera.de)