

Great tools for Tool Rebels



Câte ceva despre noi

La Wera, credem în redefinirea standardelor.

Suntem inovatori. În întreaga lume, mulți ne consideră cei mai buni din clasa noastră. Ne mândrim cu unii din cei mai buni proiectanți de produse și ingineri. Dezvoltăm unelte revoluționare care redefinesc limitele.

Dorința noastră de a transforma obișnuitul în extraordinar nu cunoaște limite și dorim să deveniți un membru al echipei noastre.

Dacă doar decât o șurubelniță, vă putem oferi una. Dacă doriți mai mult, dacă aveți nevoie de mai mult, ați ajuns în locul potrivit.

Redefinim standardul oferind utilizatorilor noștri o experiență mai confortabilă, mai sigură și mai satisfăcătoare!

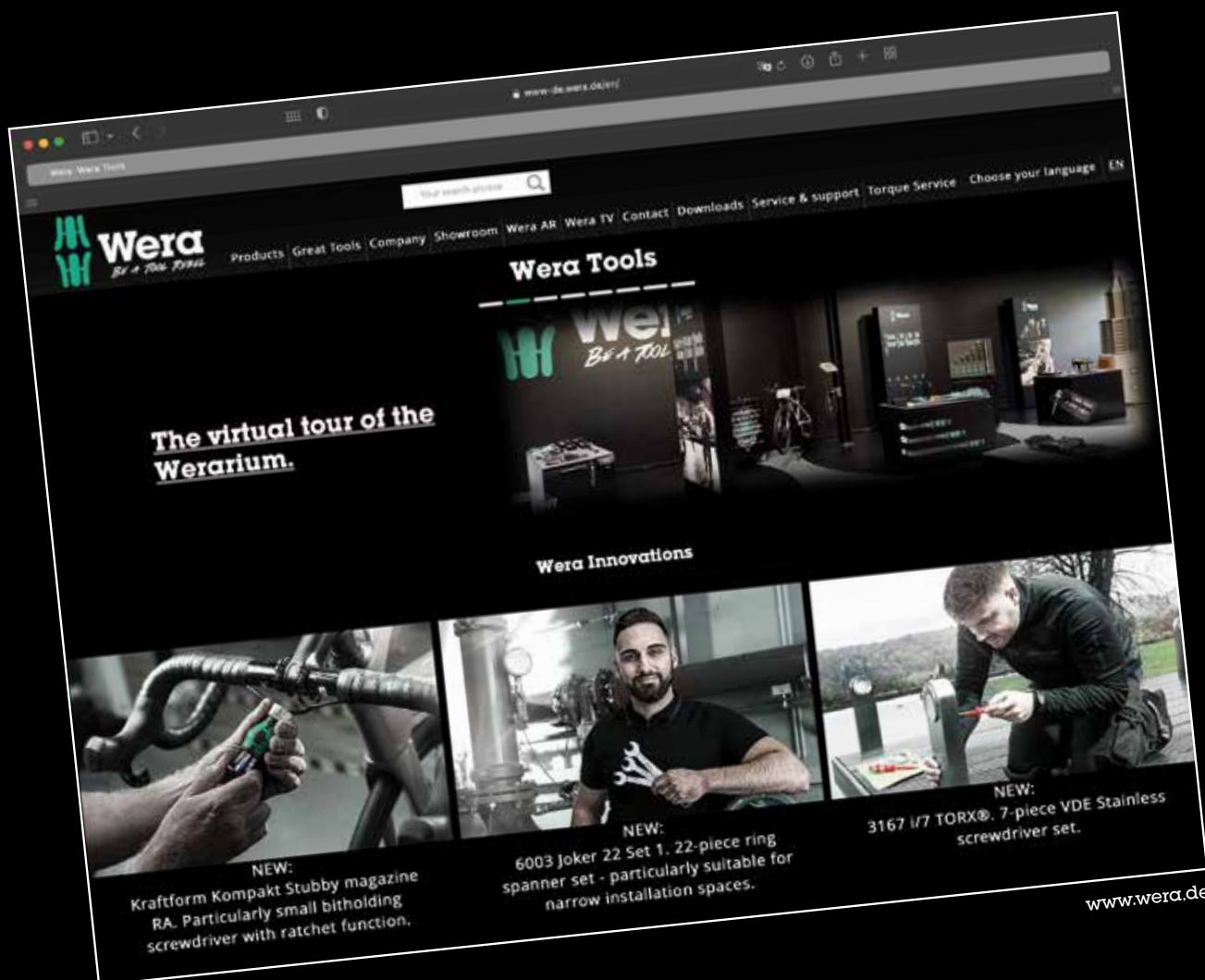



Summer Breeze 2019



Hot Air Balloon

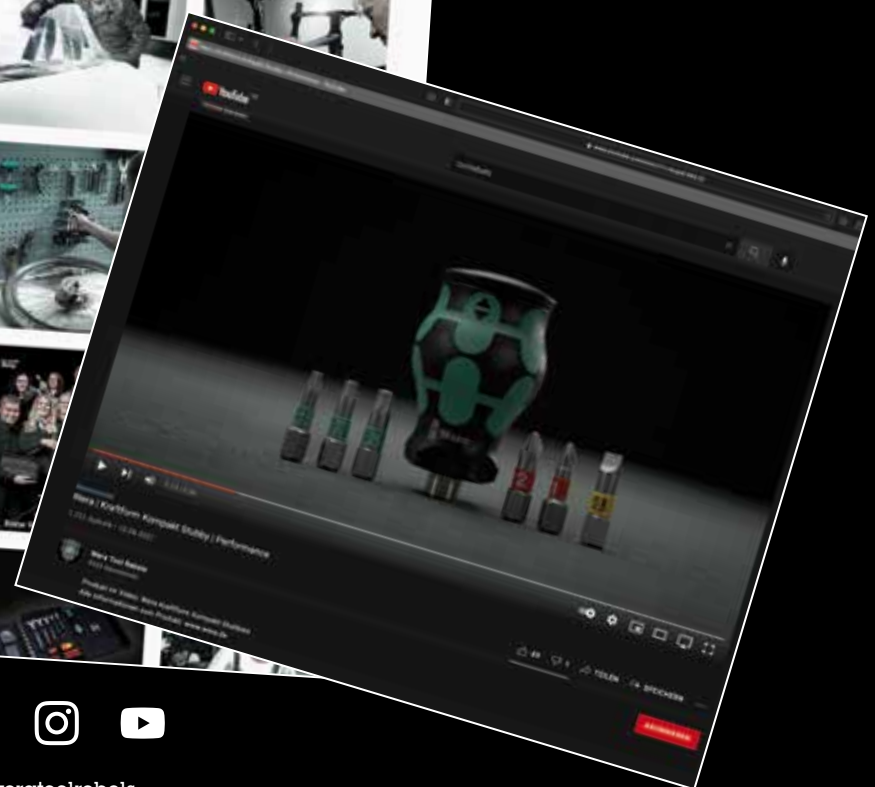
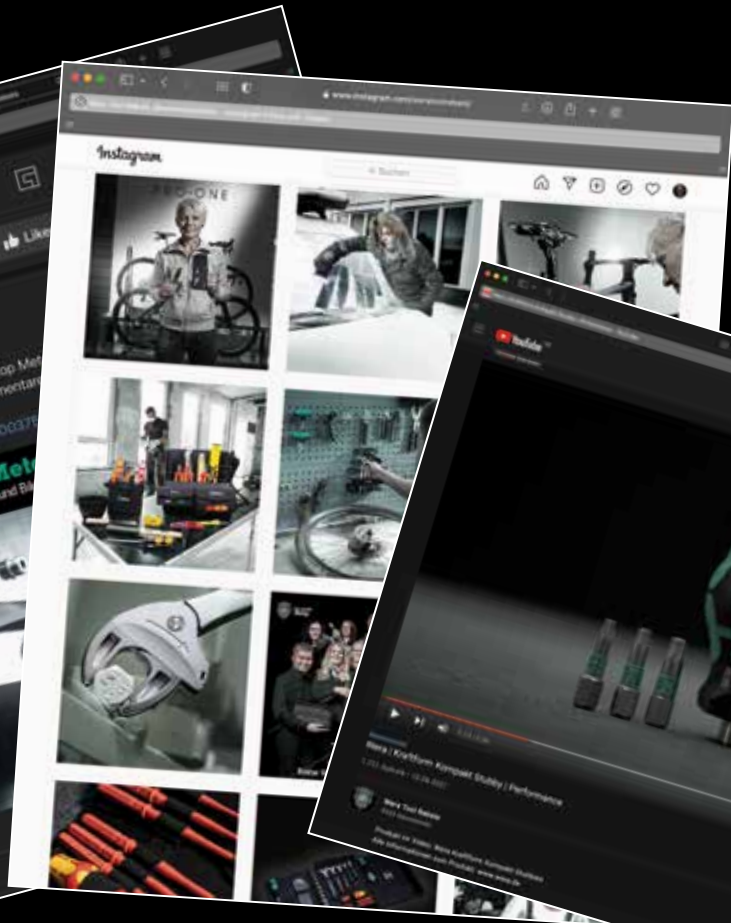
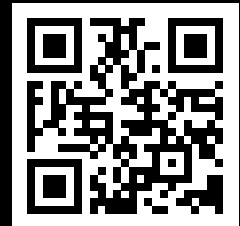

/weratoolrebels





6004 Joker 4 set 1 Set de chei clichet autoreglabile



Set de chei auto reglabile
 Set din 4 piese
 In husa textila pliabila robusta

05020110001	
	6004 Joker XS 1x 7-10x ¹ / ₄ "- ³ / ₈ "x117
	6004 Joker S 1x 10-13x ⁷ / ₁₆ "- ¹ / ₂ "x154
	6004 Joker M 1x 13-16x ¹ / ₂ "-5 ⁵ / ₈ "x188
	6004 Joker L 1x 16-19x5 ⁵ / ₈ "- ³ / ₄ "x224





Joker 6004: Autoreglare automata si continua



Cu falcile sale paralele care se prind automat si continuu, cheia Joker 6004 acopera toate dimensiunile din domeniul de aplicare respectiv. Instrumentul gaseste automat dimensiunea necesara atunci cand este asezat pe surub sau piulita, nu este necesara setarea.



Joker 6004: Delicat cu surubul

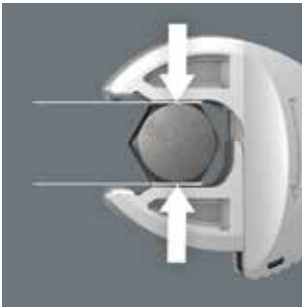

Falcile netede paralele ale Joker 6004 aplica presiune si pot preveni astfel rotunjirea surubului sau a piulitei, care poate aparea in timpul transmiterii puterii pe colturi.



Joker 6004: mecanism cu clichet pentru lucru rapid



Funcția cu clichet din falca asigura o insurubare rapida si constanta fara a scoate scula.

Joker 6004: unghi mic de retur

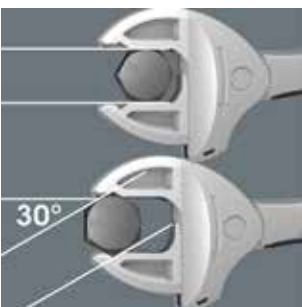

Datorita prismelor dreptunghiulare din latimea colturilor, se poate realiza un unghi de retur de numai 30°.

Cheie autoreglabila 6004 Joker XS



Aplicatii: Piulite si suruburi cu cap hexagonal cu dimensiune cheie intre 7-10 (metrica) sau 1/4"-3/8" (imperiala)

Constructie: Cheie cu reglare automata cu functie de clichet; latura gurii reglabila in functie de dimensiune, falci netede paralele; cu unghi de retur de 30° datorita prismelor dreptunghiulare pe latimea coltului din falca; gaura pentru agatare

	mm	mm	mm	mm
05020099001	7-10	1/4"-3/8"	117	7,7

Cheie autoreglabila 6004 Joker S



Aplicatii: Piulite si suruburi cu cap hexagonal cu dimensiune cheie intre 10-13 (metrica) sau 7/16"-1/2" (imperiala)

Constructie: Cheie cu reglare automata cu functie de clichet; latura gurii reglabila in functie de dimensiune, falci netede paralele; cu unghi de retur de 30° datorita prismelor dreptunghiulare pe latimea coltului din falca; gaura pentru agatare

	mm	mm	mm	mm
05020100001	10-13	7/16"-1/2"	154	10

Cheie autoreglabila 6004 Joker M



Aplicatii: Piulite si suruburi cu cap hexagonal cu dimensiune cheie intre 13-16 (metrica) sau 1/2"-5/8" (imperiala)

Constructie: Cheie cu reglare automata cu functie de clichet; latura gurii reglabila in functie de dimensiune, falci netede paralele; cu unghi de retur de 30° datorita prismelor dreptunghiulare pe latimea coltului din falca; gaura pentru agatare

	mm		mm	mm
05020103001	13-16	1/2"-5/8"	188	12,4

Cheie autoreglabila 6004 Joker XL



Aplicatii: Piulite si suruburi cu cap hexagonal cu dimensiune cheie intre 19-24 (metrica) sau 3/4"-15/16" (imperiala)

Constructie: Cheie cu reglare automata cu functie de clichet; latura gurii reglabila in functie de dimensiune, falci netede paralele; cu unghi de retur de 30° datorita prismelor dreptunghiulare pe latimea coltului din falca; gaura pentru agatare

	mm		mm	mm
05020104001	19-24	3/4"-15/16"	256	16

Cheie autoreglabila 6004 Joker L



Aplicatii: Piulite si suruburi cu cap hexagonal cu dimensiune cheie intre 16-19 (metrica) sau 5/8"-3/4" (imperiala)

Constructie: Cheie cu reglare automata cu functie de clichet; latura gurii reglabila in functie de dimensiune, falci netede paralele; cu unghi de retur de 30° datorita prismelor dreptunghiulare pe latimea coltului din falca; gaura pentru agatare

	mm		mm	mm
05020101001	16-19	5/8"-3/4"	224	14

Cheie autoreglabila 6004 Joker XXL



Aplicatii: Piulite si suruburi cu cap hexagonal cu dimensiune cheie intre 24-32 (metrica) sau 15/16"-1 1/4" (imperiala)

Constructie: Cheie cu reglare automata cu functie de clichet; latura gurii reglabila in functie de dimensiune, falci netede paralele; cu unghi de retur de 30° datorita prismelor dreptunghiulare pe latimea coltului din falca; gaura pentru agatare

	mm		mm	mm
05020102001	24-32	15/16"-1 1/4"	322	20































Cheie combinata Joker 6003



Aplicatii: Piulite si suruburi cu cap hexagonal

Constructie: Cheie combinata; capatul fix offset cu 7,5°, partea inelara pivotata cu 15°; cu instrumentul Take it easy finder: codare color dupa marime

							
		mm	mm	mm	mm	mm	mm
05020190001		5,5	105	16	4	10	6
05020198001		6	105	16	4	10	6
05020199001		7	110	17,7	4,2	11,5	6
05020200001		8	115	19	4,5	12,5	7
05020219001		9	120	21	4,8	13,5	7
05020201001		10	125	22	5	15	7
05020202001		11	135	24,5	5	17	8
05020203001		12	148	26	5,5	18	8,5
05020204001		13	160	27	6	19	8,5
05020205001		14	167	29	6	20	8,5
05020206001		15	174	32	6	22	8,5
05020207001		16	182	35	6,5	23	10
05020208001		17	190	38	6,5	24,5	10
05020209001		18	210	39	7,5	26	11,5
05020210001		19	230	42	7,5	27,5	11,5
05020500001		20	230	45	7,5	29	13
05020501001		21	260	47	7,5	30	13
05020502001		22	260	49	7,5	31,5	13
05020503001		24	280	53	8	36	14
05020504001		27	300	60	8,5	40	14,5
05020505001		30	330	66	9	43	16
05020506001		32	360	70	9,5	45,5	16,5
05020507001		36	460	80	10	50,5	18

Disponibil si in sistem
de masura imperial



6003 Joker 11 Set 1 set de chei combinate



Set de chei combinate, capatul fix offset cu 7,5°

Set de 11 piese

In husa textila robusta

05020231001	
6003 Joker	1x 8x115; 1x 10x125; 1x 11x135; 1x 12x148; 1x 13x160; 1x 14x167; 1x 15x174; 1x 16x182; 1x 17x190; 1x 18x210; 1x 19x230
K240	1x 50,0x240,0

6003 Joker 5 Set 1 set de chei combinate



Set de chei combinate, capatul fix offset cu 7,5°

Set de 5 piese

In husa textila robusta

05020230001	
6003 Joker	1x 8x115; 1x 10x125; 1x 13x160; 1x 17x190; 1x 19x230
K120	1x 50,0x120,0



Pentru locuri foarte inguste



Cheia combinata Joker 6003 cu geometria sa speciala a gurii – un decalaj la capatul fix de 7,5° si geometria hexagonala dubla – dubleaza posibilitatile de plasare atunci cand rotiti cheia cu 180° in jurul axei longitudinale. suruburile si capetele suruburilor pot fi „accesate” la fiecare 15°.

Joker 6003 va gasi automat punctul de plasare respectiv dupa fiecare tura.

Geometrie dublu hexagonala



Geometria dublu hexagonala pe laturile falcii gurii si inelului asigura conexiunea pozitiva cu capul surubului sau surubul si reduce riscul de alunecare.

Joker 6003: partea inelara inclinata la unghi

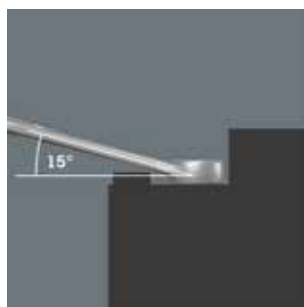

Partea inelara este inclinata la 15° fata de axa sculei pentru a preveni ranirea.

Potrivit pentru andocare cu sistemul Wera 2go



Husele Joker sunt potrivite pentru fixarea pe pereti, rafturi, carucioare de atelier si sistemul Wera 2go datorita sistemului de fixare cu scai.



Funcție de retenere



Funcția de retenere a Jokerului înseamnă că piulițele și șuruburile pot fi ținute în falca și poziționate cu ușurință acolo unde sunt necesare. Fixarea pe filet se poate face apoi rapid și în siguranță, datorită plăcii de oprire speciale inovatoare care ține elementul de fixare.

Gata cu pierderea timpului prin căutatul de piulițe și șuruburi căzute! După aplicarea și poziționarea piuliței sau a șurubului, fixarea poate începe imediat - nu sunt necesare unelte suplimentare.

Geometrie dublu hexagonală



Geometria inteligentă dublu-hexagonală a lui Joker oferă o conexiune foarte bună cu piulițele sau șuruburile - se potrivește perfect. Iar placa de prindere din metal, schimbabilă, dură din din gura Jokerului mușcă literalmente în șurub, cu varfurile sale extrem de dure. Ambele caracteristici

se combină pentru a preveni alunecarea, chiar și la un cuplu mai mare.

Mecanism dantura fină



Clichetul de la capătul inelar are o dantură foarte fină - 80 de dinți în total - care oferă o flexibilitate mai mare, chiar și în spațiile de lucru foarte restrânse.



6000/6002 Joker 6 Set 1 Set de chei combinate cu clichet / chei fixe



Set chei clichet mixt combinate/chei fixe duble

Set din 6 piese

Husa textila rezistenta

05020022001	
6000 Joker	1x 10x159; 1x 13x177; 1x 17x224; 1x 19x246
6002 Joker Double	1x 10x13x167; 1x 17x19x235

6001 Joker Switch 11 Set 1 Set de chei combinate cu clichet



Set de chei combinate cu clichet, reversibile

Set de 11 piese

In husa textila rezistenta

05020091001	
6001 Joker Switch	1x 8x144; 1x 10x159; 1x 11x165; 1x 12x171; 1x 13x179; 1x 14x187; 1x 15x199; 1x 16x213; 1x 17x225; 1x 18x234; 1x 19x246
K240	1x 50,0x240,0

6000 Joker 4 Set 1 Set de chei combinate cu clichet



Set de chei combinate cu clichet

Set din 4 piese

In husa textila robusta

05073290001	
6000 Joker	1x 10x159; 1x 13x177; 1x 17x224; 1x 19x246

6002 Chei fixe duble Joker



Aplicatii: Piulite si suruburi cu cap hexagonal

Design: Chei fixe duble

		mm	mm	mm	mm	mm	mm
05003760001		10	23	13	27	5,5	7
05003765001		17	37	19	42	8,5	9,5
05020260001		20	48	22	51	10	10
05020261001		22	48	24	51	10	10
05020262001		24	51	27	60	11	11
05020263001		27	63	32	66	12	12
05020264001		30	63	32	66	12	12



826 T Kraftform Turbo Maner surubelnita port-bit cu mandrina eliberare rapida Rapidaptor



Aplicatii: Pentru biti cu antrenare externa hexagon 1/4"- conform DIN ISO 1173-C 6,3 si E 6,3 si conexiuni Wera seria 1 si 4

Constructie: Functie turbo mecanica on/off pentru cvadruplarea vitezei de insurubare; angrenaj robust, fara intretinere, fabricat din otel; mandrina 1/4" hexagon cu tehnologie Rapidaptor cu intrare rapida, iesire rapida, rotire rapida, chuck-all si functii cu o singura mana, magnetic

Maner: Kraftform cu protectie anti-rolare, multi-component

		mm
05057480001	1/4"	146

Kraftform Kompakt Turbo 1

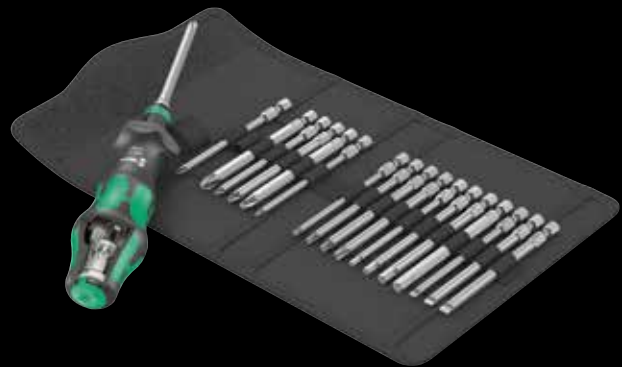

Husa textila pliabila cu biti lungi de 89 mm

Set de 19 piese

Kraftform Turbo cu 1 bit cu mandrina cu eliberare rapida Rapidaptor

05057482001		
	826 T Kraftform Turbo	1x 1/4"x146
	851/4 Z PH	1x PH 1x89; 1x PH 2x89; 1x PH 3x89
	855/4 Z PZ	1x PZ 1x89; 1x PZ 2x89; 1x PZ 3x89
	867/4 Z TORX®	1x TX 10x89; 1x TX 15x89; 1x TX 20x89; 1x TX 25x89; 1x TX 30x89
	840/4 Z Hex-Plus	1x 3,0x89; 1x 4,0x89; 1x 5,0x89; 1x 6,0x89
	800/4 Z	1x 0,8x4,0x89; 1x 1,0x5,5x89; 1x 1,2x6,5x89
	K120	1x 50,0x120,0



Insurubare mai rapida



Constructia Kraftform Turbo permite multiplicarea de 4 ori a vitezei de insurubare manuala, in special pentru asamblari usoare - fara electricitate!

Cu si fara Turbo



Funcția turbo poate fi activată la nevoie apăsând un buton. Oprirea acestuia este recomandată pentru strângere și slabire cu cuplu ridicat, de ex. pentru asamblări cu suruburi în lemn, precum și pentru reglaje fine.

827 T i Kraftform Turbo Maner tija interschimbabila



Aplicatii: Numai pentru tijele interschimbabile Wera VDE

Constructii: Functie turbo mecanica on/off pentru cvadruplarea vitezei de insurubare; angrenaj robust, fara intretinere, fabricate din otel

Maner: Kraftform cu protectie anti-rolare, multi-component

	mm	mm
05057481001	9	125

Kraftform Kompakt Turbo i 1



Set de 16 piese

1 Maner 817 Kraftform VDE si 1 Maner 827 T i Kraftform Turbo; ambele doar pentru tijele interschimbabile Wera VDE

14 tije interschimbabile VDE (fiecare 154 mm lungime) cu diametrul redus al lamei (articolele KK 60 i 0,4x2,5 si KK 67 i TX 10 diametrul standard al lamei) cu izolatie de protectie integrata, astfel incat sa poata ajunge si antrena suruburi si elemente de siguranta cu arc din alezaje mai adanci

05057484001		
	827 T i Kraftform Turbo	1x 9x125
	817 VDE	1x 9x102
	KK 62 iS	1x PH 1x154; 1x PH 2x154
	KK 65 iS PZ	1x PZ 1x154; 1x PZ 2x154
	KK 65 iS PZ/S	1x # 1x154; 1x # 2x154
	KK 67 i TORX®	1x TX 10x154
	KK 67 iS	1x TX 15x154; 1x TX 20x154; TORX® 1x TX 25x154
	KK 60 i	1x 0,4x2,5x154
	KK 60 iS	1x 0,6x3,5x154; 1x 0,8x4,0x154; 1x 1,0x5,5x154
	K120	1x 50,0x120,0



Insurubare mai rapida



Constructia Kraftform Turbo permite multiplicarea de 4 ori a vitezei de insurubare manuala, in special pentru asamblari usoare – fara electricitate!

Cu si fara Turbo



Functia turbo poate fi activata la nevoie apasand un buton. Opirrea acestuia este recomandata pentru strangere si slabire cu un cuplu ridicat, precum si pentru reglaje fine.

Sistem maner cu tije interschimbabile



Cu montarea sa de 9 mm, Kraftform Turbo este potrivit pentru toate lamele interschimbabile Wera Kraftform Kompakt VDE. „Sistemul de fixare / cu lama interschimbabila” reprezinta o functionare flexibila pentru multe profile de surub.



Testate individual



Testarea individuala la 10.000 de volti, in conformitate cu IEC 60900, asigura lucrul in siguranta la tensiuni de pana la 1.000 de volti.



Lama telescopica, magazie de biti integrata, tehnologie Rapidaptor



Seturile din seria Kraftform Kompakt 20 sunt cu adevarat ceva. O lama telescopica in 2 pozitii care poate fi retrasa in maner pentru o functionare in spatiu restrans sau extinsa pentru o mai mare acoperire. Poate fi, de asemenea, indepartata si utilizata ca suport de biti de 100 mm in

scula electrica. sase biti sunt integrati convenabil intr-o magazie de biti de deschidere cu buton. Tehnologia Rapidaptor asigura schimbări rapide de biti cu o singura mana, blocare automata a bitului prin apasare si o pozitionare sigura atunci cand este utilizata in unelte electrice datorita mansonului cu rotire libera.



TELESCOPE
BLADE

Tija telescopica I



Cand tija telescopica este coborata in maner, este posibila o actiune rapida si usoara de insurubare, chiar si in cele mai stranse locuri!

Kraftform Kompakt 20 Tool Finder 1 cu husa textila



Aplicații: Pentru biti cu antrenare hexagonală 1/4" DIN ISO 1173-C 6.3 și E 6.3 și Wera Seria 1 și 4

Construcție: Accesoriu, telescopic, Rapidaptor rapid-in, rapid-out, rapid-spin, chuck-all și tehnologie schimbare bit cu o singură mână; Identificator scule „Take it easy”: codare color și marcaj dimensional mare pentru a permite localizarea ușoară a bitului dorit.

Mâner: Kraftform cu caracteristică non-roll, magazie integrată cu mai multe componente,

05051016001		
889/4 R	1x 1/4"x100	
851/1 BTZ PH	1x PH 1x25; 1x PH 2x25	
855/1 BTZ PZ	1x PZ 1x25; 1x PZ 2x25	
867/1 TORX® BTZ	1x TX 25x25	
800/1 BTZ	1x 0,8x5,5x25	
K70	1x 50,0x70,0	

Kraftform Kompakt 60



Husa cu biti de 89 mm

Set de 17 piese

1 surubelnita Kraftform 816 R cu mandrina cu eliberare rapida Rapidaptor

05059295001		
816 R	1x 1/4"x119	
851/4 Z PH	1x PH 1x89; 1x PH 2x89; 1x PH 3x89	
855/4 Z PZ	1x PZ 1x89; 1x PZ 2x89; 1x PZ 3x89	
867/4 Z TORX® BO	1x TX 10x89; 1x TX 15x89; 1x TX 20x89; 1x TX 25x89; 1x TX 30x89	
800/4 Z	1x 1,0x5,5x89	
840/4 Z Hex-Plus	1x 3,0x89; 1x 4,0x89; 1x 5,0x89; 1x 6,0x89	
K70	1x 50,0x70,0	

Kraftform Kompakt 400

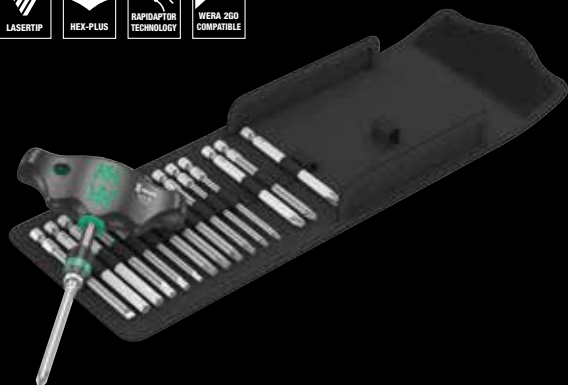

Husa textila pliabila cu biti lungi de 89 mm

Set de 17 piese

Suport manual 416 R maner T cu mandrina cu eliberare rapida Rapidaptor

05057470001		
●	416 R	1x 1/4"x45
+	851/4 Z PH	1x PH 2x89; 1x PH 3x89
+	855/4 Z PZ	1x PZ 2x89; 1x PZ 3x89
⊖	867/4 Z TORX®	1x TX 10x89; 1x TX 15x89; 1x TX 20x89; 1x TX 25x89; 1x TX 30x89; 1x TX 40x89
○	840/4 Z Hex-Plus	1x 3,0x89; 1x 4,0x89; 1x 5,0x89; 1x 6,0x89; 1x 8,0x89
⊖	800/4 Z	1x 1,0x5,5x89
	K120	1x 50,0x120,0

Kraftform Kompakt Stubby 1

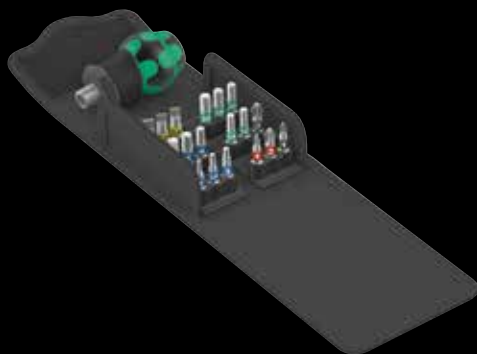

Cutie textila cu biti lungi de 25 mm

Set de 19 piese

1 surubelnita bitholding 811/1 Stubby, 18 biti

05057471001		
●	811/1 Stubby	1x 1/4"
+	851/1 BTZ PH	1x PH 1x25; 1x PH 2x25
+	855/1 BTZ PZ	1x PZ 1x25; 1x PZ 2x25
⊖	867/1 TORX® BTZ	1x TX 10x25; 1x TX 15x25; 1x TX 20x25; 1x TX 25x25; 1x TX 30x25
○	840/1 BTZ Hex-Plus	1x 2,0x25; 1x 2,5x25; 1x 3,0x25; 1x 4,0x25; 1x 5,0x25; 1x 5,5x25
⊖	800/1 BTZ	1x 0,8x5,5x25; 1x 1,0x5,5x25; 1x 1,2x6,5x25
	K70	1x 50,0x70,0

Transfer cuplu mare

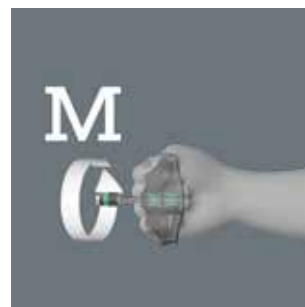

Folosind tija surubelnitei ca o extensie a antebratului puteti transfera un cuplu deosebit de mare.

Maner T ergonomic bicomponent



Manerul T bicomponent, cu forma ergonomica, cu degajari pentru degete si o suprafata placuta tactil, faciliteaza transmitia foarte mare a puterii si lucrul fara oboseala.

Forma compacta



Cu forma manerului compact si tija scurta, Kraftform Stubbies sunt deosebit de potrivite pentru lucrul in spatii de insurubare restranse.



Ergonomie tangibila



Manerul Kraftform cu 2 componente permite transmiterea mare a puterii datorita zonelor de prindere mai aderente si mai moi si a vitezelor de lucru ridicate datorita zonelor de prindere dure, care permit rotirea rapida.

Kraftform Kompakt



De ce adesea nu avem scula potrivita la indemana? Motivul: prea multe unelte si truse de scule prea grele pot face ca sa fie deranjant sa le transportati la fata locului. Asadar, pentru noi a fost o provocare clara: sa proiectam o scula care sa fie potrivita pentru o gama larga de aplicatii si care sa poata fi

transportata cu usurintape teren. Solutia noastra: sculele Kraftform Kompakt. Un maner in care pot fi introduse tije cu o gama de profile diferite.

Kraftform Kompakt Pistol RA 4



Set de 13 piese

1 suport manual portabil 814 RA Kraftform, Magazie integrata, cu functie de clichet, design dantura fina pentru unghi minim de retur, inel de comutare (dreapta, blocat, stanga), cuplu maxim de pana la 50 Newton metri, mandrina hexagonala de 1/4" cu tehnologie Rapidaptor, adica functie de intrare rapida, de iesire rapida, de rotire rapida, de mandrina si de o singura mana pentru schimbarea rapida a bitilor, magnetica, 6 biti de 25 mm lungime, potrivit pentru suporturi conform DIN ISO 1173-D 6.3 si 6 biti de 89 mm lungime, pentru suporturi conform DIN ISO 1173-F 6.3

Husa textila

	
05051031001	
	814 RA 1x 1/4"
+	851/1 BTZ PH 1x PH 1x25; 1x PH 2x25
+	855/1 BTZ PZ 1x PZ 1x25; 1x PZ 2x25
+	867/1 TORX® 1x TX 20x25; 1x TX 25x25
	BTZ
+	851/4 Z PH 1x PH 1x89; 1x PH 2x89
+	855/4 Z PZ 1x PZ 1x89; 1x PZ 2x89
+	867/4 Z 1x TX 20x89; 1x TX 25x89
	TORX®



Kraftform Kompakt VDE 18 Universal 1



1 maner Kraftform 817 VDE numai pentru tije interschimbabile Wera VDE

Tije interschimbabile VDE (fiecare 154 mm lungime)

Tester de faza monofazat

Set 18 piese

05003471001		
⦿	817 VDE	1x 9x102
⊕	KK 62 i	1x PH 1x154; 1x PH 2x154
⊕	KK 62 i PH/S	1x # 1x154; 1x # 2x154
⊕	KK 65 i PZ	1x PZ 1x154; 1x PZ 2x154
⊕	KK 65 i PZ/S	1x # 1x154; 1x # 2x154
⊖	KK 60 i	1x 0,4x2,5x154; 1x 0,6x3,5x154; 1x 0,8x4,0x154; 1x 1,0x5,5x154
⦿	KK 96 VK 6,3	1x 6,3x89
⦿	KK 97 VK 8,1	1x 8,1x89
⦿	KK 98 DK	1x 89
⦿	KK 99 FL	1x 89
⊖	247	1x 0,5x3,0x70
⊖	K70	1x 50,0x70,0

⚠ Produs indisponibil in USA si Canada.



Kraftform Kompakt VDE 7 extra subtire 1



1x Maner suport manual 817 VDE Kraftform doar pentru tije interschimbabile Wera VDE

6 tije interschimbabile VDE (fiecare 154 mm lungime) cu diametrul redus al tijeii cu izolare de protectie integrata, permite accesul si actionarea suruburilor si a elementelor de arc din alezaje adanci.

Set de 7 piese

05003475001		
⦿	817 VDE	1x 9x102
⊕	KK 62 iS	1x PH 1x154; 1x PH 2x154
⊕	KK 65 iS PZ/S	1x # 2x154
⊕	KK 67 iS	1x TX 15x154; 1x TX 20x154
⊖	KK 60 iS	1x 0,6x3,5x154
⊖	K70	1x 50,0x70,0

Schimbare rapida



Seturile Kraftform Kompakt VDE sunt prevazute cu un maner izolat si lame interschimbabile izolate, care pot fi schimbate fara unelte speciale.



Kraftform Kompakt VDE 16 Torque 1.2-3.0 Nm extra subtire 1



1 seria 7400 VDE maner surubelnita dinamometrica cuplu reglabil Kraftform (1,2 - 3,0 Nm) si 1 maner Kraftform 817 VDE numai pentru tije interschimbabile Wera VDE

Tijele interschimbabile VDE (fiecare 154 mm lungime) cu diametrul lamei reduse (articolele KK 60 i 0,4x2,5 si KK 67 i TX 10 diametrul conventional) si cu izolatie de protectie integrata, permit accesarea si actionarea suruburilor in alezaje adanci si a elementelor de siguranta cu arc

Set de 16 piese



Maner surubelnita dinamometrica, cuplu reglabil Kraftform pentru electricieni



Setarea simpla a momentului necesar cu mana.



Semnal de suprasarcina



Semnal de declansare distinct audibil si vizibil la atingerea cuplului prestabilit.

05135906001		
⊙	7400 VDE	1x 7441 VDE, 1,2-3,0 Nm
⊙	817 VDE	1x 9x102
⊕	KK 62 iS	1x PH 1x154; 1x PH 2x154
⊕	KK 65 iS PZ	1x PZ 1x154; 1x PZ 2x154
⊕	KK 65 iS PZ/S	1x # 1x154; 1x # 2x154
⊕	KK 67 i TORX®	1x TX 10x154
⊕	KK 67 iS TORX®	1x TX 15x154; 1x TX 20x154; 1x TX 25x154
⊖	KK 60 i	1x 0,4x2,5x154
⊖	KK 60 iS	1x 0,6x3,5x154; 1x 0,8x4,0x154; 1x 1,0x5,5x154
	K70	1x 50,0x70,0

Kraftform Kompakt VDE 17 extra subtire 1



Set de 17 piese

2 manere Kraftform 817 VDE numai pentru tijele interschimbabile Wera VDE

14 tije interschimbabile VDE (fiecare 154 mm lungime) cu diametrul redus al lamei (articole KK 60 i 0,4x2,5 si KK 67 i TX 10 diametru conventional) cu izolatie de protectie integrata, permite accesul si actionarea suruburilor si a elementelor de siguranta cu arc din alezaje mai adanci. 1 patent electrician Knipex VDE 13 96 200; pentru taiere, decupare, prindere, indoire, debavurare si sertizare. Cu clichet pentru o actionare usoara. Cromat pentru o mai buna protectie impotriva ruginii, cu invelisuri izolate multicomponent.



Testate individual



Fiecare set Kraftform Kompakt VDE a fost testat individual la 10.000 de volti, in conformitate cu IEC 60900. Aceasta sarcina de testare de zece ori mai mare garanteaza o functionare sigura la sarcina maxima admisa de 1.000 de volti.

Sistem maner cu tije interschimbabile



Sistemul cu maner / lama interschimbabila permite schimbul rapid al lamelor necesare pentru o gama larga de aplicatii.

05136027001		
●	817 VDE	2x 9x102
⊕	KK 62 iS	1x PH 1x154; 1x PH 2x154
⊕	KK 65 iS PZ	1x PZ 1x154; 1x PZ 2x154
⊕	KK 65 iS PZ/S	1x # 1x154; 1x # 2x154
⊗	KK 67 i TORX®	1x TX 10x154
⊗	KK 67 iS TORX®	1x TX 15x154; 1x TX 20x154; 1x TX 25x154
⊖	KK 60 i	1x 0,4x2,5x154
⊖	KK 60 iS	1x 0,6x3,5x154; 1x 0,8x4,0x154; 1x 1,0x5,5x154
	K70	1x 50,0x70,0





Wera 2go 1 Tool Carrier

Wera 2go 2 Tool Container



1 Tool Carrier pentru scule cu sistem de fixare scai pentru atasarea altor componente Wera 2go precum si cutii si huse textile Wera cu zone de fixare cu scai; 1 curea de umar cu captuseala cu latime reglabila, reglabila in lungime, detasabila.

	
05004350001	
Wera 2go 5	1x 135,0x300,0x270,0
Wera 2go 6	1x 38,0x1470,0



1 Container de scule robust dimensional, cu sistem de fixare cu scai pentru atasarea altor componente Wera 2go, precum si cutii si huse textile Wera cu zone de fixare cu scai ; rezistenta ridicata la taieturi si intepaturi; 1 maner si 1 curea de umar cu captuseala cu latime reglabila, reglabila in lungime, detasabila; 1 tolba de scule detasabila cu maner si o partitie variabila de fixare cu scai bucla pentru o impartire in pana la 5 sectiuni interioare.

05004351001	
Wera 2go Container	1x 355,0x330,0x115,0
Wera 2go 6	1x 38,0x1470,0
Wera 2go 4	1x 165,0x165,0x105,0

Wera 2go 2 XL Tool Container



1 Container de unelte stabil, robust pentru pana la patru tolbe de scule Wera 2go; cu sistem de fixare cu scai pentru atasarea altor componente Wera 2go precum si cutii si huse textile Wera cu zone de fixare cu scai; rezistenta ridicata la taieturi si intepaturi; 1 maner si 1 curea de umar cu captuseala cu latime reglabila, reglabila in lungime, detasabila; 1 cutie textila detasabila cu maner

05004357001	
Wera 2go XL Container	1x 455,0x330,0x170,0
Wera 2go 6	1x 38,0x1470,0
Wera 2go 4	1x 165,0x165,0x105,0

Wera 2go 3 Tool Box



1 Cutie textila de scule stabila si robusta dimensional, goala, echipata cu maner pentru depozitarea si transportul sculelor si a pieselor mici; rezistenta ridicata la taieturi si intepaturi; vine cu zona de fixare cu scai pentru andocare cu sistemul Wera 2go.

	mm	mm	mm
05004352001	130,0	325,0	80,0

Wera 2go 7 High Tool Box



1 Cutie de scule inalta robusta, robusta, cu maner de transport, pentru depozitarea si transportul sculelor lungi si a pieselor de schimb. Rezistenta ridicata la taieturi si intepaturi. Cu zone de fixare cu scai pentru andocare pe sistemul Wera 2go.

	mm	mm	mm
05004356001	295,0	100,0	100,0

Versatil



Wera 2go Tool Container XL cu sistem de fixare cu scai. Configurabil individual pentru o mobilitate mai mare. Ideal, de asemenea, pentru andocarea cutiilor si pungilor textile Wera echipate cu zone de fixare cu scai. Introducere si indepartare usoara. Mainile raman libere in timpul transportului.



Ce cutii textile pot fi andocate pe sistemul Wera 2go fara alte accesorii ajutatoare?



Ambalajele Wera care poarta acest simbol contin huse pentru scule sau cutii textile cu scai care pot fi andocate cu Sistemul Wera 2go.

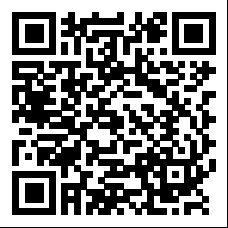

Zyklop VDE

Dorim ca utilizatorii uneltelor noastre să lucreze în siguranță și confort. Clichetul Zyklop VDE și accesoriile acestuia sunt sculele potrivite pentru lucrul la instalații electrice, cu caracteristici care vor impresiona chiar și în spații restrânse.

Zyklop Speed

Produsul Zyklop „original” este deosebit de impresionant deoarece combină 5 tipuri de clicheturi într-o singură unealtă și asigură cele mai mari viteze de lucru. Ambele caracteristici simplifică și accelerează lucrul. Având în vedere aceste aspecte, produsul Zyklop original va fi cunoscut drept Zyklop Speed de acum înainte.

Zyklop Hybrid

Am dorit să combinăm cele mai solicitate avantaje ale unui clichet într-o singură unealtă. Ideea noastră a fost să dezvoltăm un clichet ușor într-un mâner Kraftform ergonomic, o construcție cu cap subțire, o tijă lungă și o opțiune de extensie. Vă prezentăm... Zyklop Hybrid.



Zyklop Metal

Clicheții Zyklop Metal sunt fabricați în întregime din metal (crom-molibden), de aceea sunt denumiți Zyklop Metal. Noua ramură a familiei va include Zyklop Metal cu antrenare pătrată „prin împingere” și Zyklop Metal cu pârghie de schimbare a sensului.



Zyklop Mini

Construcție filigranată cu robustețe incredibilă – aceasta este o uneltă de uz industrial. Clichețul Wera Bit este utilizat oriunde spațiul este insuficient pentru utilizarea unei unelte electrice sau a unor unelte manuale convenționale.

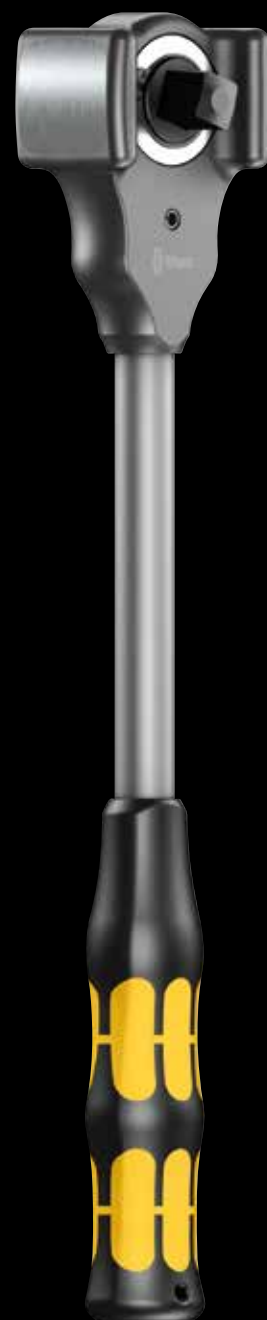

Koloss

Clichețul poate fi utilizat în siguranță și oficial și ca ciocan! Koloss este un clicheț reversibil pentru regim intens de solicitare care poate fi utilizat cu o sarcină de cel puțin 600 Nm.

8007 B Clichet VDE Zyklop, izolat, cu parghie schimbare de sens, cu antrenare 3/8"



Aplicatie: Tubulare cu antrenare patrat de 3/8" precum si pentru adaptoare de 3/8" cu antrenare patrata, cu dispozitiv de blocare cu bila

Design: Testat individual conform IEC 60900 la 10.000 V pentru lucru in siguranta la tensiunea aprobata de 1.000 V; design subtire pentru a permite lucrul in spatii foarte inguste; mecanism cu dinti fini cu 80 de dinti pentru un unghi de intoarcere de numai 4,5°; parghie schimbare de sens pentru schimbarea convenabila a directiei; functie de blocare sigura a tubularelor prin buton

		mm
05004966001	3/8"	222,0

8100 SB VDE 1 Set clichet Zyklop, izolat, parghie schimbare de sens, antrenare 3/8", metric



17 piese; intr-o cutie textila compacta si extrem de robusta care protejeaza suprafata; volum si greutate reduse pentru o mobilitate crescuta. Suport prindere cu scai pentru atasare usoara, de ex. g. pe perete, raft, carucior de atelier sau la sistemul de transport scule Wera 2go. Mecanism de rotire usoara pentru fixarea in siguranta si extragerea usoara a tubularelor Zyklop VDE din cutie.

1 clichet Zyklop 8007 B VDE, cu parghie schimbare de sens, cu antrenare de 3/8", 14 tubulare Zyklop VDE, 2 prelungitoare Zyklop VDE, unul lung si unul scurt, toate sculele izolate, testate individual conform IEC 60900 la 10.000 V pentru lucrul in siguranta la tensiunea aprobata de 1.000 V. Tubularele si prelungitoarele Zyklop VDE ofera o siguranta sporita prin izolatia bicomponenta cu miez izolator galben, care devine vizibil in cazul deteriorarii stratului de izolatie VDE rosu de la exterior



Parghie schimbare de sens



Parghie pentru schimbarea usoara de sens.

Blocaj cu bila



Blocarea cu bila asigura montarea sigura a tubularelor si accesoriilor, asigurand o siguranta sporita in timpul functionarii. O apasare scurta pe butonul de eliberare permite schimbarea rapida a instrumentului.

05004970001		
	8007 B VDE	1x 3/8"x222,0
	8790 B VDE	1x 6.0x46,0; 1x 7.0x46,0; 1x 8.0x46,0; 1x 9.0x46,0; 1x 10.0x46,0; 1x 11.0x46,0; 1x 12.0x46,0; 1x 13.0x46,0; 1x 14.0x46,0; 1x 15.0x46,0; 1x 16.0x46,0; 1x 17.0x46,0; 1x 18.0x46,0; 1x 19.0x46,0
	8794 SB VDE	1x 3/8"x91.0
	8794 LB VDE	1x 3/8"x166.0
	K240	1x 50.0x240.0

Siguranta sporita



Tubularele Zyklop si extensiile pentru electricieni ofera o siguranta sporita datorita izolarii lor din 2 componente cu miez de izolatie galben sub strat exterior de izolatie rosie.





Clichet Zyklop Speed 8000 A cu antrenare de 1/4"







Aplicatie: Capete tubulare cu antrenare patrat de 1/4" si adaptoare de 1/4" cu antrenare patrata, echipate cu blocare cu sfera

Design: Design cu rotiata de antrenare directa si manson liber rotitor pentru o munca mai rapida, cap clichet pivotant, pozitii de blocare predefinite la 0° si 90° la stanga si la dreapta, precum si la 15° inainte de 90° spre interior, la 0° poate fi folosit ca o surubelnita conventionala, buton de apasare pentru eliberare, comutare stanga/dreapta, design cu dantura fina, unghi mic de retur 5°

Maner: Manerul multicomponent Kraftform asigura o oboseala minima

		
		8" mm
05003500001	1/4"	152.0

		
		8" mm
05003550001	3/8"	199.0

		
		8" inch mm
05003600001	1/2"	277.0





8100 SA 6 Zyklop Speed Set clichet, 1/4", metric



Set de 28 de piese; intr-o cutie textila care protejeaza suprafata sculelor, compacta si extrem de robusta; volum si greutate reduse pentru mobilitate simplificata

1 clichet Zyklop Speed cu antrenare de 1/4", 9 tubulare Zyklop, 1 prelungitor Zyklop (lung) cu manson rotativ, 1 prelungitor oscilant, 1 adaptor cu mandrina cu eliberare rapida, 15 biti

05004016001		
○	8000 A	1x 1/4"x152,0
●	8790 HMA	1x 5,0x23,0; 1x 5,5x23,0; 1x 6,0x23,0; 1x 7,0x23,0; 1x 8,0x23,0; 1x 10,0x23,0; 1x 11,0x23,0; 1x 12,0x23,0; 1x 13,0x23,0
●○	8794 LA	1x 1/4"x150,0
●○	8794 A	1x 1/4"x56,0
●●	8784 A1	1x 1/4"x1/4"x37,0
+	851/4 TZ PH	1x PH 1x50; 1x PH 2x50; 1x PH 3x50
+	855/4 TZ PZ	1x PZ 1x50; 1x PZ 2x50
⊕	867/4 Z	1x TX 10x50; 1x TX 15x50; 1x TX 20x50; 1x TX 25x50; 1x TX 27x50; 1x TX 30x50
○	840/4 Z	1x 3,0x50; 1x 4,0x50; 1x 5,0x50;
	Hex-Plus	1x 6,0x50
	K120	1x 50,0x120,0

8100 SB 6 Zyklop Speed Set clichet, 3/8", metric



Set de 29 de piese; intr-o cutie textila pentru protejarea suprafetei sculelor, compacta si extrem de robusta; volum si greutate reduse pentru mobilitate simplificata

1 clichet Zyklop Speed cu antrenare de 3/8", 9 tubulare Zyklop, 1 extensie Zyklop (lunga) cu manson rotativ, 1 extensie oscilanta, 1 adaptor cu mandrina cu eliberare rapida, 16 biti

05004046001		
○	8000 B	1x 3/8"x199,0
●	8790 HMB	1x 8,0x29,0; 1x 10,0x29,0; 1x 12,0x29,0; 1x 13,0x29,0; 1x 15,0x29,0; 1x 16,0x30,0; 1x 17,0x30,0; 1x 18,0x30,0; 1x 19,0x30,0
●○	8794 LB	1x 3/8"x200,0
●○	8794 B	1x 3/8"x76,0
●●	8784 B1	1x 1/4"x3/8"x44,0
+	851/4 TZ PH	1x PH 1x50; 1x PH 2x50; 1x PH 3x50
+	855/4 TZ PZ	1x PZ 1x50; 1x PZ 2x50; 1x PZ 3x50
⊕	867/4 Z	1x TX 20x50; 1x TX 25x50; 1x TX 27x50; 1x TX 30x50; 1x TX 40x50
○	840/4 Z	1x 4,0x50; 1x 5,0x50; 1x 6,0x50;
	Hex-Plus	1x 8,0x50
○	800/4 Z	1x 1,0x5,5x50



8100 SC 6 Zyklop Speed Set clichet, 1/2", metric



Set de 28 de piese; într-o cutie textilă pentru protejarea suprafeței sculelor, compactă și extrem de robustă; volum și greutate reduse pentru mobilitate simplificată

1 clichet Zyklop Speed cu antrenare de 1/2", 10 tubulare Zyklop, 1 extensie Zyklop (lungă) cu manșon rotativ, 1 extensie oscilantă, 1 adaptor cu mandrină cu eliberare rapidă, 14 biti

05004076001		
○	8000 C	1x 1/2"x277,0
●	8790 HMC	1x 10,0x37,0; 1x 11,0x37,0; 1x 12,0x37,0; 1x 13,0x37,0; 1x 14,0x37,0; 1x 15,0x37,0; 1x 16,0x37,0; 1x 17,0x37,0; 1x 18,0x37,0; 1x 19,0x37,0
○	8794 LC	1x 1/2"x250,0
○	8794 C	1x 1/2"x52,0
●	8784 C2	1x 5/16"x1/2"x50,0
+	851/2 Z PH	1x PH 2x32; 1x PH 3x32
+	855/2 Z PZ	1x PZ 2x32; 1x PZ 3x32
⊗	867/2 Z	1x TX 20x35; 1x TX 25x35; 1x TX 30x35; 1x TX 40x35; 1x TX 45x35; 1x TX 50x35
○	840/2 Z	1x 5x30; 1x 6x30; 1x 8x30; 1x 10x30

Zyklop "6 in 1"



1. Clichet cu dinți fini 2. Clichet cu cap flexibil 3. Clichet cu unghi 4. Clichet cu eliberare rapidă 5. Clichet de putere 6. surubelnita



Pivotează liber



Capul cu clichet pivotează liber și poate fi blocat în orice poziție predefinită folosind comutatorul glisant care este poziționat pe ambele părți. Este chiar posibil să lucrați în zone foarte restrânse și dificil de accesat, cu o distanță sporită a mâinilor. Blocarea predefinită la 0°, 15° și 90°, atât la dreapta,

cât și la stânga, asigură o funcționare sigură fără alunecări la capul clichetului.



Unghi mic de retur



Clichetul reversibil cu 72 de dinți cu pas fin are un unghi redus de retur de numai 5°. Aceasta cursă scurtă permite lucrul rapid și precis în toate tipurile de asamblare.

8100 SA All-in Zyklop Speed Set clichet, antrenare 1/4", cu functie de retinere, metric



Set de 42 de piese; intr-o cutie textila pentru protejarea suprafetelor sculelor, compacta si extrem de robusta; volum si greutate reduce pentru mobilitate simplificata. Benzi scai pentru atasare simpla de ex. la un perete, raft, carucior de scule si la sistemul de transport al sculei Wera 2go. Mecanism Twist to Unlock (rasuciti pentru deblocare) rapid si usor pentru stocare sigura si extragerea simpla a tubularelor.

1 clichet Zyklop Speed cu actionare de 1/4", 13 tubulare Zyklop cu actionare de 1/4" cu functie de retinere, 9 tubulare bit Zyklop pentru suruburi TORX®, cu actionare de 1/4", cu functie de retinere, 8 tubulare bit pentru suruburi cu locas hexagon al cu antrenare de 1/4" cu functie de retinere (dimensiunile 2.0 si 2.5 fara functie de mentinere) si geometrie Hex-Plus, 3 tubulare bit Zyklop cu antrenare de 1/4" pentru suruburi Phillips, 3 tubulare bit Zyklop cu antrenare 1/4" pentru suruburi Pozidriv, 2 tubulare bit Zyklop pentru biti cu antrenare de 1/4" pentru suruburi cu locas cu crestatura, sistem de identificare scule "Take it easy": codare color pentru a permite selectarea usoara a tubularei dorite, 1 accesoriu pentru indepartarea simpla a piulitelor din tubularele cu functie de retinere, 1 extensie Zyklop (lunga) cu manson rotativ, 1 extensie oscilanta.

05003755001		
○	8000 A	1x 1/4"x152,0
● ○	8796 LA	1x 1/4"x150,0
● ○	8794 A	1x 1/4"x56,0
●	8790 HMA HF	1x 4,0x23,0; 1x 4,5x23,0; 1x 5,0x23,0; 1x 5,5x23,0; 1x 6,0x23,0; 1x 7,0x23,0; 1x 8,0x23,0; 1x 9,0x23,0; 1x 10,0x23,0; 1x 11,0x23,0; 1x 12,0x23,0; 1x 13,0x23,0; 1x 14,0x23,0
⊕	8767 A HF	1x TX 8x28,0; 1x TX 9x28,0; 1x TX 10x28,0; 1x TX 15x28,0; 1x TX 20x28,0; 1x TX 25x28,0; 1x TX 27x28,0; 1x TX 30x28,0; 1x TX 40x28,0
○	8740 A	1x 2,0x28,0; 1x 2,5x28,0
○	8740 A HF	1x 3,0x28,0; 1x 4,0x28,0; 1x 5,0x28,0; 1x 6,0x28,0; 1x 7,0x28,0; 1x 8,0x28,0
⊕	8751 A	1x PH 1x28,0; 1x PH 2x28,0; 1x PH 3x28,0
⊕	8755 A	1x PZ 1x28,0; 1x PZ 2x28,0; 1x PZ 3x28,0
●	8700 A FL	1x 0,8x5,5x28,0; 1x 1,2x6,5x28,0
	ME1	1x 14,0x43,0
	K120	1x 50,0x120,0



Tubulare bit cu functie de retinere pentru suruburi TORX®



Instrumentele HF dezvoltate de Wera sunt ideale deoarece au o geometrie optimizata a profilului original TORX®. Fortele de impanare rezultate din presiunea suprafetei dintre varful de actionare si profilul surubului fac ca suruburile TORX® realizate conform specificatiilor Acument

Intellectual Properties sa fie tinute in siguranta pe scula!



Miscare rapida



Clichetele Zyklop Speed sunt foarte rapide. Proiectarea masei rotative accelereaza insurubarea. Structura simetrica de rotatie a manerului Kraftform si mansonul cu rotire libera accentueaza acest proces de rasucire rapida, in special atunci cand clichetul nu seupleaza din cauza rezistentei prea mici a filetelui.



Schimbare simpla a directiei



Toti clichetii Zyklop Speed dispun de o roata cu zimti in capul clichetului care poate fi utilizata pentru a comuta rapid si usor intre rotatia in sensul acelor de ceasornic si in sens invers acelor de ceasornic, in orice pozitie. Fara manipulare complicata, fara pierderi de timp!

8006 C Zyklop Hybrid Clichet cu parghie schimbare de sens si antrenare 1/2"

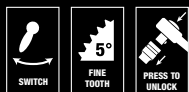

Aplicatii: Tubulare cu antrenare patrat de 1/2", precum si pentru adaptoare de 1/2" cu unitate patrata, cu dispozitiv de blocare cu bila

Proiectare: Mecanism cu dinti fini cu 72 de dinti pentru un unghi de retur de numai 5°; parghie pentru pentru schimbarea convenabila a sensului; functie de blocare ferma a tubularei

Maner: Maner Krafftform multicomponent pentru presiune optima si sarcini de tractiune, capatul manerului proiectat pentru conectarea prelungitorului Zyklop Hybrid 8797 C

		mm	mm	mm
05003780001	1/2"	281,0	34	37

8797 C Zyklop prelungitor Hybrid



Aplicatii: Prelungitor pentru utilizare cu Wera Zyklop Hybrid 8006 C pentru a creste transferul de

Constructie: Otel Cr-Mo dur, temperat

Maner : Maner Krafftform multi-component pentru presiune optima si sarcini de intindere; cu pin de eliberare a prelungitorului

	mm	mm
05003781001	271,0	134,0

8006 SC 1 Zyklop Hybrid Set clichet, antrenare 1/2", metric



Transfer de cuplu mai mare



Lungime totala mai mare pentru un transfer de cuplu mai mare.

Prelungitor Hybrid



Se poate aplica un moment mai mare utilizand extensia.

Ideal pentru lucrul in spatii restranse



Cap clichet foarte ingust.

Set de 13 piese; intr-o cutie textila pentru protejarea suprafetei sculelor, compacta si extrem de robusta; volum si greutate reduse pentru mobilitate simplificata

1 clichet Zyklop Hybrid cu actionare de 1/2", 10 tubulare Zyklop cu functie de retinere, 1 prelungitor Zyklop Hybrid cu stiff de eliberare, 1 prelungitor Zyklop (lunga) cu manson rotativ

05004090001			
	8006 C	1x 1/2"x281,0	
	8797 C	1x 271,0	
	8794 LC	1x 1/2"x250,0	
	8790 HMC HF	1x 10,0x37,0; 1x 11,0x37,0; 1x 12,0x37,0; 1x 13,0x37,0; 1x 14,0x37,0; 1x 15,0x37,0; 1x 16,0x37,0; 1x 17,0x37,0; 1x 18,0x37,0; 1x 19,0x37,0	
	K240	1x 50,0x240,0	



Zyklop Metal Push



Datorita mediului de lucru din ce in ce mai aglomerat, spatiul devine din ce in ce mai mult o problema in folosirea clichetelor. Prin urmare, dezvoltatorii nostri de produse s-au ocupat intens de problema spatiilor de lucru restranse, iar Wera a rezolvat acum aceasta problema. Rezultatul a fost

Zyklop Metal extrem de subtire si robust, cu un maner lung. Cand schimbarea de directie trebuie sa fie rapida, clichetul Zyklop Metal Switch este instrumentul potrivit. Cand tubulara nu trebuie sa cada trebuie evitate schimbarile accidentale de directie, Zyklop Metal Push este alegerea corecta.



8003 A Clichet Zyklop Metal cu patrat push-through si antrenare de 1/4"

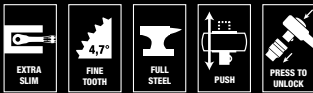

Aplicatie: Tubulare cu antrenare patrata de 1/4" precum si pentru adaptoare de 1/4" cu antrenare patrata, cu dispozitiv de blocare cu bila

Design: Clichet din metal forjat in intregime (crom-molibden), extrem de robust, cu o durata de viata lunga; design subtire pentru a permite lucrul in spatii foarte inguste; designul danturii duble a clichetului, permite obtinerea a 76 de dinti fini din cei 38 de dinti robusti cu un unghi de intoarcere de numai 4,7°; schimbare simpla a directiei cu patratul nedetasabil si mecanism foarte sigur de blocare a capetelor tubulare

	mm	mm	mm	mm
05004003001	1/4"	141	21	22

	mm	mm	mm	mm
05004033001	3/8"	222,0	27	29

	mm	mm	mm	mm
05004063001	1/2"	281	36	37

8100 SA 7 Zyklop Metal Set clichet cu patrat push-through, antrenare 1/4", metric



Set de 28 de piese; intr-o cutie textila care protejeaza suprafata sculelor, compacta si extrem de robusta; volum si greutate reduse pentru mobilitate simplificata

1 clichet Zyklop Metal cu antrenare de 1/4", 9 tubulare Zyklop, 1 prelungitor Zyklop (lung) cu mansion rotativ, 1 prelungitor oscilant, 1 adaptor cu mandrina cu eliberare rapida, 15 biti

05004017001		
	8003 A	1x 1/4"x141
	8790 HMA	1x 5,0x23,0; 1x 5,5x23,0; 1x 6,0x23,0; 1x 7,0x23,0; 1x 8,0x23,0; 1x 10,0x23,0; 1x 11,0x23,0; 1x 12,0x23,0; 1x 13,0x23,0
	8794 LA	1x 1/4"x150,0
	8794 A	1x 1/4"x56,0
	8784 A1	1x 1/4"x1/4"x37,0
	851/1 Z PH	1x PH 1x25; 1x PH 2x25; 1x PH 3x25
	855/1 Z PZ	1x PZ 1x25; 1x PZ 2x25
	867/1 TORX®	1x TX 10x25; 1x TX 15x25; 1x TX 20x25; 1x TX 25x25; 1x TX 27x25; 1x TX 30x25
	840/1 Z Hex-Plus	1x 3,0x25; 1x 4,0x25; 1x 5,0x25; 1x 6,0x25



8100 SB 7 Zyklop Metal Set clichet cu patrat push-through, $\frac{3}{8}$ " , metric



Set de 29 de piese; intr-o cutie textila pentru protejarea suprafetei sculelor, compacta si extrem de robusta; volum si greutate reduse pentru mobilitate simplificata

1 clichet Zyklop Metal push through cu antrenare de $\frac{3}{8}$ " , 9 tubulare Zyklop, 1 extensie Zyklop (lunga) cu manson rotativ, 1 extensie oscilanta, 1 adaptor cu mandrina cu eliberare rapida, 16 biti

05004047001		
○	8003 B	1x $\frac{3}{8}$ "x222,0
●	8790 HMB	1x 8,0x29,0; 1x 10,0x29,0; 1x 12,0x29,0; 1x 13,0x29,0; 1x 15,0x29,0; 1x 16,0x30,0; 1x 17,0x30,0; 1x 18,0x30,0; 1x 19,0x30,0
○	8794 LB	1x $\frac{3}{8}$ "x200,0
○	8794 B	1x $\frac{3}{8}$ "x76,0
●	8784 B1	1x $\frac{1}{4}$ "x $\frac{3}{8}$ "x44,0
+	851/1 Z PH	1x PH 1x25; 1x PH 2x25; 1x PH 3x25
+	855/1 Z PZ	1x PZ 1x25; 1x PZ 2x25
⊕	867/1 TORX®	1x TX 15x25; 1x TX 20x25; 1x TX 25x25; 1x TX 27x25; 1x TX 30x25; 1x TX 40x25
○	840/1 Z Hex-Plus	1x 3,0x25; 1x 4,0x25; 1x 5,0x25; 1x 6,0x25; 1x 8,0x25

8100 SC 7 Zyklop Metal Set clichet cu patrat push-through, $\frac{1}{2}$ " , metric



Set de 29 de piese; intr-o cutie textila pentru protejarea suprafetei sculelor, compacta si extrem de robusta; volum si greutate reduse pentru mobilitate simplificata

1 clichet Zyklop Metal cu antrenare de $\frac{1}{2}$ " , 10 tubulare Zyklop, 1 extensie Zyklop (lunga) cu manson rotativ, 1 extensie oscilanta, 1 adaptor cu mandrina cu eliberare rapida, 14 biti

05004077001		
○	8003 C	1x $\frac{1}{2}$ "x281,0
●	8790 HMC	1x 10,0x37,0; 1x 11,0x37,0; 1x 12,0x37,0; 1x 13,0x37,0; 1x 14,0x37,0; 1x 15,0x37,0; 1x 16,0x37,0; 1x 17,0x37,0; 1x 18,0x37,0; 1x 19,0x37,0
○	8794 LC	1x $\frac{1}{2}$ "x250,0
○	8794 C	1x $\frac{1}{2}$ "x52,0
●	8784 C2	1x $\frac{9}{16}$ "x $\frac{1}{2}$ "x50,0
+	851/2 Z PH	1x PH 2x32; 1x PH 3x32
⊕	867/2 Z TORX®	1x TX 20x35; 1x TX 25x35; 1x TX 27x35; 1x TX 30x35; 1x TX 40x35; 1x TX 45x35; 1x TX 50x35; 1x TX 55x35
○	840/2 Z	1x 5x30; 1x 6x30; 1x 8x30; 1x 10x30



Reversibil



Parghie pentru schimbarea usoara de sens.



8004 A Clichet Zyklop Metal cu parghie schimbare de sens si antrenare de 1/4"



Aplicatie: Tubulare cu antrenare patrat de 1/4" precum si pentru adaptoare de 1/4" cu antrenare patrata, cu dispozitiv de blocare cu bila

Design: Clichet din metal forjat integral (crom-molibden), extrem de robust, cu o durata de viata lunga; design subtire pentru a permite lucrul in spatii foarte inguste; mecanism cu dantura fina cu 72 de dinti pentru un unghi de retur de numai 5°; parghie pentru schimbarea usoara a directiei de antrenare; functie de blocare sigura a tubularei

		mm	mm	mm
05004004001	1/4"	141	19	22

		mm	mm	mm
05004034001	3/8"	222,0	26	29

		mm	mm	mm
05004064001	1/2"	281	34	37

8100 SA 8 Zyklop Metal Set clichet cu parghie schimbare de sens, 1/4", metric



Set de 28 de piese, intr-o cutie textila care protejeaza suprafata sculelor, compacta si extrem de robusta; volum si greutate reduse pentru mobilitate simplificata

1 clichet Zyklop Metal cu parghie schimbare sens, cu antrenare de 1/4", 9 tubulare Zyklop, 1 prelungitor Zyklop (lung) cu manson rotativ, 1 prelungitor oscilant, 1 adaptor cu mandrina cu eliberare rapida, 15 biti

05004018001			
	8004 A	1x 1/4"x141	
	8790 HMA	1x 5,0x23,0; 1x 5,5x23,0; 1x 6,0x23,0; 1x 7,0x23,0; 1x 8,0x23,0; 1x 10,0x23,0; 1x 11,0x23,0; 1x 12,0x23,0; 1x 13,0x23,0	
	8794 LA	1x 1/4"x150,0	
	8794 A	1x 1/4"x56,0	
	8784 A1	1x 1/4"x1/4"x37,0	
	851/1 Z PH	1x PH 1x25; 1x PH 2x25; 1x PH 3x25	
	855/1 Z PZ	1x PZ 1x25; 1x PZ 2x25	
	867/1 TORX®	1x TX 10x25; 1x TX 15x25; 1x TX 20x25; 1x TX 25x25; 1x TX 27x25; 1x TX 30x25	
	840/1 Z Hex-Plus	1x 3,0x25; 1x 4,0x25; 1x 5,0x25; 1x 6,0x25	
	K120	1x 50,0x120,0	



8100 SB 8 Zyklop Metal set clichet cu parghie schimbare de sens, 3/8", metric



Set de 29 de piese; intr-o cutie textila pentru protejarea suprafetii sculelor, compacta si extrem de robusta; volum si greutate reduse pentru mobilitate simplificata

1 clichet Zyklop Metal cu antrenare de 3/8", 9 tubulare Zyklop, 1 extensie Zyklop (lunga) cu manson rotativ, 1 extensie oscilanta, 1 adaptor cu mandrina cu eliberare rapida, 16 biti

05004048001		
○	8004 B	1x 3/8"x222,0
●	8790 HMB	1x 8,0x29,0; 1x 10,0x29,0; 1x 12,0x29,0; 1x 13,0x29,0; 1x 15,0x29,0; 1x 16,0x30,0; 1x 17,0x30,0; 1x 18,0x30,0; 1x 19,0x30,0
○	8794 LB	1x 3/8"x200,0
○	8794 B	1x 3/8"x76,0
●	8784 B1	1x 1/4"x3/8"x44,0
+	851/1 Z PH	1x PH 1x25; 1x PH 2x25; 1x PH 3x25
+	855/1 Z PZ	1x PZ 1x25; 1x PZ 2x25
+	867/1 TORX®	1x TX 15x25; 1x TX 20x25; 1x TX 25x25; 1x TX 27x25; 1x TX 30x25; 1x TX 40x25
○	840/1 Z Hex-Plus	1x 3,0x25; 1x 4,0x25; 1x 5,0x25; 1x 6,0x25; 1x 8,0x25

8100 SC 8 Zyklop Metal Set clichet cu parghie schimbare de sens, 1/2", metric



Set de 28 de piese; intr-o cutie textila pentru protejarea suprafetii sculelor, compacta si extrem de robusta; volum si greutate reduse pentru mobilitate simplificata

1 clichet Zyklop Metal cu antrenare de 1/2", 10 tubulare Zyklop, 1 extensie Zyklop (lunga) cu manson rotativ, 1 extensie oscilanta, 1 adaptor cu mandrina cu eliberare rapida, 14 biti

05004078001		
○	8004 C	1x 1/2"x281,0
●	8790 HMC	1x 10,0x37,0; 1x 11,0x37,0; 1x 12,0x37,0; 1x 13,0x37,0; 1x 14,0x37,0; 1x 15,0x37,0; 1x 16,0x37,0; 1x 17,0x37,0; 1x 18,0x37,0; 1x 19,0x37,0
○	8794 LC	1x 1/2"x250,0
○	8794 C	1x 1/2"x52,0
●	8784 C2	1x 5/16"x1/2"x50,0
+	851/2 Z PH	1x PH 2x32; 1x PH 3x32
+	867/2 Z TORX®	1x TX 20x35; 1x TX 25x35; 1x TX 27x35; 1x TX 30x35; 1x TX 40x35; 1x TX 45x35; 1x TX 50x35; 1x TX 55x35
○	840/2 Z	1x 5x30; 1x 6x30; 1x 8x30; 1x 10x30

Kraftform Kompakt Zyklop Mini 2

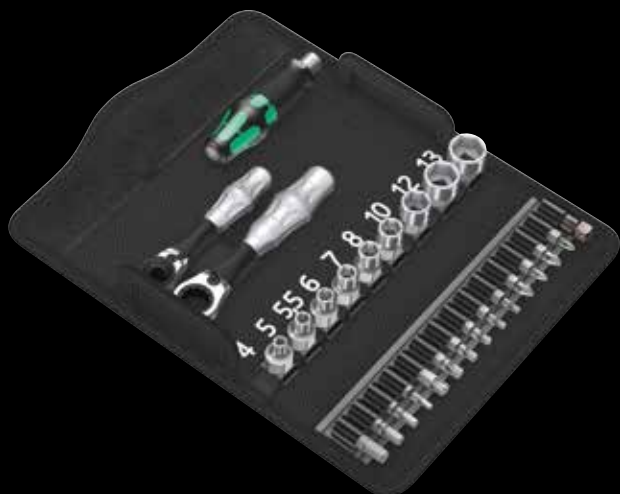

1 Clichet Wera Bit Zyklop Mini 1, construit integral din otel, pentru biti hexagonali de 1/4" conform DIN ISO 1173-C 6.3 si E 6.3 si Wera seria 1 si 4. Poate fi utilizat si cu tubularele de 1/4" folosind adaptorul Wera 870/1. 1 Clichet Wera Zyklop Mini 2, construit complet din otel, potrivit pentru tubulare Wera 8790 FA. 9 tubulare Wera 8790 FA, 1 adaptor de tubulare 870/1, 14 biti, duri, pentru uz universal

05135918001		
⊖	8001 A	1x 1/4"x87,0
	8005	1x 107
⊙	813	1x 1/4"x78
⊖ ⊙	870/1	1x 1/4"x25 ¹⁾
+	851/1 Z PH	1x PH 1x25; 1x PH 2x25
+	855/1 Z PZ	1x PZ 1x25; 1x PZ 2x25
⊕	867/1 TORX®	1x TX 10x25; 1x TX 15x25; 1x TX 20x25; 1x TX 25x25; 1x TX 30x25; 1x TX 40x25
⊖	840/1 Z Hex-Plus	1x 3,0x25; 1x 4,0x25; 1x 5,0x25; 1x 6,0x25
⊙	8790 FA	1x 4,0; 1x 5,0; 1x 5,5; 1x 6,0; 1x 7,0; 1x 8,0; 1x 10,0; 1x 12,0; 1x 13,0
	K120	1x 50,0x120,0

¹⁾Cu sfera retinere; pentru tubulare manuale

Zyklop Mini 2



Zyklop Mini 2 este potrivit pentru atasarea directa a tubularelor speciale Wera Zyklop 8790 FA. Aceste tubulare au o inaltime foarte mica, ideale pentru spatii de lucru restranse.

Clichet Zyklop Mini 3



Clichetul Zyklop Mini 3 este instrumentul ideal pentru insurubarea in spatii restranse. Dantura fina (60 de dinti) permite un unghi de retur foarte mic de numai 6°; roata zimtata permite insurubarea rapida chiar si atunci cand nu exista spatiu pentru miscare pivotanta.

Insurubare rapida



Roata zimtata din capul clichet actionata cu degetul mare permite insurubarea rapida, chiar si atunci cand nu exista suficient spatiu pentru utilizarea bratului clichetului.



Sistem identificare scule "Take it easy"



Bit-Check-urile „Take it Easy” au biti cu mansoni care - din culoarea sa (de ex. Rosu = Phillips) si marcarea dimensiunilor - faciliteaza accesarea rapida a bitului potrivit.

Bit-Check 10 Zyklop Mini BiTorsion 1



Set 9 biti, BiTorsion pentru o durata lunga de viata, extra-dur, pentru utilizare universala. Sistem identificare "Take it Easy": codarea culorilor de iesire (rosu = Phillips; negru = Pozidriv; verde = TORX®; albastru = hexagon) si marcaj dimensional mare pentru a permite localizarea usoara a bitului dorit. 1 Clichet Wera Bit Zyklop Mini 1, construit complet din otel, pentru biti hexagonali de 1/4" conform DIN ISO 1173-C 6.3 si E 6.3 si Wera seria 1 si 4. Poate fi utilizat si cu tubulare 1/4" folosind adaptorul de tubulare Wera 870/1.

05057418001		
○	8001 A	1x 1/4"x87,0
⊕	851/1 BTZ PH	1x PH 1x25; 1x PH 2x25
⊕	855/1 BTZ PZ	1x PZ 1x25; 1x PZ 2x25
⊗	867/1 TORX®	1x TX 15x25; 1x TX 20x25; 1x TX 25x25
	BTZ	
○	840/1 BTZ	1x 4,0x25; 1x 5,0x25
	Hex-Plus	

8001 A Zyklop Mini 1 Clichet pentru bit 1/4" SB cu antrenare 1/4"

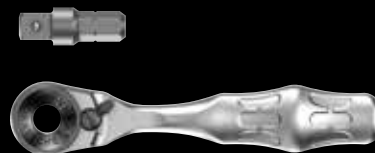

Aplicatii: Potrivit pentru biti hexagonali de 1/4" conform DIN ISO 1173-C 6.3 si E 6.3 si Wera seria 1 si 4, adaptor Wera 870/1 pentru tubulare de 1/4"

Constructie: Proiectat completa din otel forjat, mecanism cu clichet cu dantura fina, unghi mic de retur de numai de 6°, comutator de actionare inainte si inapoi

Maner: Manerul Kraftform cu geometria Kraftform dovedita ofera zone de contact cu degetele perfect proiectate, cap de clichet si maner ergonomic

05073230001		
○	8001 A	1x 1/4"x87,0
○	870/1	1x 1/4"x25 ¹⁾

¹⁾Cu sfera retinere; pentru tubulare manuale

8008 A Zyklop Mini 3 Clichet cu antrenare 1/4"

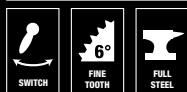

Aplicatii: Tubulare cu actionare 1/4" patrate si adaptoare de 1/4" cu actionare patrata, echipate cu bila de blocare

Design: Design forjat complet din otel, mecanism clichet dantura fina, unghi mic de retur 6°, parghie de schimbare de sens

Maner: Manerul Kraftform cu geometrie Kraftform dovedita ofera zone de contact cu degetele perfect proiectate, capul clichet si maner ergonomic.

05003793001	1/4"	87,0
-------------	------	------

8005 Zyklop Mini 2 Clichet



Aplicatii: Potrivit pentru tubulare Wera 8790 FA

Proiectare: Design forjat complet din otel, mecanism cu clichet dantura fina, unghi mic de revenire de 6°, parghie schimbare de sens

Maner: Manerul Kraftform cu geometrie Kraftform dovedita ofera zone de contact cu degetele perfect concepute, capul cu clichet si maner ergonomic

05003660001	107
-------------	-----

Tool-Check PLUS



Set 28 de biti, 1 Maner surubelnita port bit 813 adecvata pentru atasarea de biti cu actionare hexagonala de 1/4" conform DIN ISO 1173-C 6.3 si conexiunea Wera seria 1, 1 suport de biti Rapidaptor, 1 adaptor 870/1 (1/4" hexagon la 1/4" patrat), 7 tubulare (1/4"); 1 Clichet Wera Bit Zyklop Mini 1, construit complet din otel, pentru atasarea de biti cu actionare hexagonala de 1/4" conform DIN ISO 1173-C 6.3 si E 6.3 si conexiunile Wera seria 1 si 4; utilizarea tubulelor de 1/4" este posibila cu aplicarea adaptorului Wera 870/1

05056490001		
⊙	8001 A	1x 1/4"x87,0
⊙	813	1x 1/4"x78
⊙	889/4/1 K	1x 1/4"x50
⊙	870/1	1x 1/4"x25 ¹⁾
⊙	8790 HMA	1x 5,5x23,0; 1x 6,0x23,0; 1x 7,0x23,0; 1x 8,0x23,0; 1x 10,0x23,0; 1x 12,0x23,0; 1x 13,0x23,0
⊕	851/1 TZ PH	2x PH 1x25; 3x PH 2x25; 1x PH 3x25
⊕	855/1 TH PZ	1x PZ 1x25; 3x PZ 2x25; 1x PZ 3x25
⊕	867/1 TZ TORX®	1x TX 10x25; 1x TX 15x25; 1x TX 20x25; 1x TX 25x25; 1x TX 30x25; 1x TX 40x25
⊕	867/1 Z TORX® BO	1x TX 10x25; 1x TX 15x25; 1x TX 20x25; 1x TX 25x25; 1x TX 30x25
⊙	840/1 Z Hex-Plus	1x 3,0x25; 1x 4,0x25; 1x 5,0x25; 1x 6,0x25; 1x 8,0x25
⊕	800/1 TZ	1x 1,0x5,5x25

¹⁾Cu sfera retinere; pentru tubulare manuale

Este o scula atat de mica suficient de rezilienta?



Clichetul Zyklop Mini 1 poate prelua momente de cel puțin 65 Nm. Ceea ce reprezinta mai multa forta decat este normal transferata de o scula cu dimensiuni atat de reduse.

781/5 Set 1



Set adaptori tubulara, set 5 piese

Pentru unelte manuale si actionate de masini (fara impact), cu canelura de oprire a bilei, randalinate la capat pentru prindere buna in timpul utilizarii manuale; crom-vanadiu, finisaj cromat periat

781 A: antrenor patrat de 1/4", pentru inserturi tubulare cu prindere de 3/8" si 1/2" cu sfera blocare; 781 B: antrenor patrat de 3/8", pentru inserturi tubulare cu antrenare 1/4" si 1/2"; 781 C: antrenor patrat de 1/2", pentru inserturi tubulare de 3/8" cu blocare cu sfera.

05042680001		
⊙	781 A	1x 781 A/B, 3/8"x25.2x1/4"; 1x 781 A/C, 1/2"x36.0x1/4"
⊙	781 B	1x 781 B/A, 1/4"x27.0x3/8"; 1x 781 B/C, 1/2"x36.0x3/8"
⊙	781 C	1x 781 C/B, 3/8"x35.5x1/2"
	Belt 781 0/5	1x 45.0x210.0



Prindere sigura si extragere usoara



Noul mecanism de rotire usoara garanteaza atat stocarea sigura, cat si fara zgomot, dar permite si indepartarea usoara a sculei.



Tubulare cu functie de retinere pentru piulite, bolturi si suruburi cu cap hexagonal



Strangerea surubului se realizeaza printr-un sistem de retinere a bilelor cu doua arcuri. Tubul este protejat eficient impotriva uzurii mecanice de catre un inel de otel. Functia de mentinere este utila in special in spatii restranse, greu accesibile, in care nu exista spatiu pentru o a doua mana care sa fixeze surubul.

Belt A 1 Zyklop set tubulare pe sina textila cu functie de retinere, antrenare 1/4"

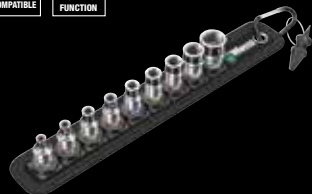

Set de 10 piese; sina textila robusta, inclusiv carabiniera de prindere pentru a permite fixarea sigura la o bucla sau la un buzunar. Benzi scai pentru atasare simpla de ex. la un perete, raft, carucior de scule si la sistemul de transport al sculelor Wera 2go. Mecanism Twist to Unlock (rasuceste pentru deblocare) pentru stocare sigura si extragerea simpla a tubulelor.

9 tubulare Zyklop cu actionare de 1/4" cu functie de fixare. Sistem identificare "Take it easy"; codare color pentru a permite selectarea usoara a tubulei dorite. 1 dispozitiv pentru extragerea simpla a piulitelor din tubularele cu functie de retinere.

05003880001	
●	8790 HMA HF 1x 4,0x23,0; 1x 4,5x23,0; 1x 5,0x23,0; 1x 5,5x23,0; 1x 6,0x23,0; 1x 7,0x23,0; 1x 8,0x23,0; 1x 10,0x23,0; 1x 13,0x23,0
	ME1 1x 14,0x43,0
	Belt A 0/9 1x 39,0x238,0
	K30 1x 30,0x200,0

Belt B 3 TORX® HF Set tubulare bit Zyklop cu functie de retinere, 3/8"

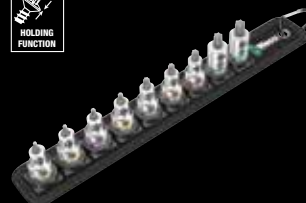

Set de 9 piese; sina textila robusta, inclusiv carabiniera pentru a permite fixarea sigura la o bucla sau la un buzunar. Benzi scai pentru atasare simpla de ex. la un perete, raft, carucior de scule si la sistemul de transport al sculelor Wera 2go. Mecanism Twist to Unlock (rasuceste pentru deblocare) pentru stocare sigura si extragerea simpla a tubulelor.

9 Tubulare bit Zyklop pentru suruburi TORX®, cu actionare de 3/8", cu functie de retinere. Identificator de scule "Take it easy"; codare color pentru a permite selectarea usoara a tubulei bit dorite.

05003972001	
⊕	8767 B HF 1x TX 10x35,0; 1x TX 15x35,0; 1x TX 20x35,0; 1x TX 25x35,0; 1x TX 27x35,0; 1x TX 30x35,0; 1x TX 40x35,0; 1x TX 45x38,5; 1x TX 50x38,5
	Belt B 0/9 1x 45,0x310,0
	K30 1x 30,0x200,0

Belt A Deep 1 set tubulare lungi pe sina textila, 1/4"

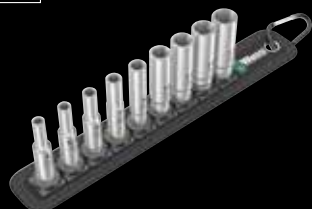

Set de 9 piese; Sina textila robusta, inclusiv carabiniera de prindere pentru a permite fixarea sigura la o bucla sau la un buzunar. Suprafata scai atasare simpla de ex. la un perete, raft, carucior de scule si la sistemul de transport al sculelor Wera 2go. Mecanism rapid si usor Twist to Unlock (rasuceste pentru deblocare) pentru depozitare sigura si indepartarea usoara a tubulelor.

9 tubulare lungi cu actionare de 1/4". Constructie lunga pentru suruburi in alezaje adanci si tije filetate proeminente, cu profil hexagonal. Sistem cautare scule "Take it easy"; codare color pentru a permite selectarea usoara a tubulei dorite.

05004525001	
●	8790 HMA Deep 1x 5,0x50,0; 1x 5,5x50,0; 1x 6,0x50,0; 1x 7,0x50,0; 1x 8,0x50,0; 1x 10,0x50,0; 1x 11,0x50,0; 1x 12,0x50,0; 1x 13,0x50,0
	Belt A 0/9 1x 39,0x238,0
	K30 1x 30,0x200,0

Belt C Impaktor 1 Set tubulare pe sina textila, 1/2"

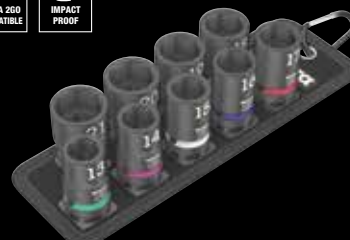

Set de 9 piese; sina textila robusta inclusiv carabiniera de prindere pentru a permite fixarea sigura la o bucla sau la un buzunar. Benzi scai pentru atasare simpla de ex. la un perete, raft, carucior de scule si la sistemul de transport al sculelor Wera 2go. Mecanism Twist to Unlock (rasuceste pentru deblocare) rapid si usor pentru stocare sigura si extragerea simpla a tubulelor.

9 Tubulare Impaktor cu actionare 1/2", cu profil hexagonal si profil canelat. Pentru utilizare cu masini electrice sau pneumatice cu impact cu 12,5 mm = actionare 1/2". Identificator "Take it easy"; codare color pentru a permite selectarea usoara a tubulei dorite.

05004580001	
●	8790 C Impaktor 1x 13,0x38,0; 1x 14,0x38,0; 1x 15,0x38,0; 1x 16,0x38,0; 1x 17,0x38,0; 1x 18,0x38,0; 1x 19,0x38,0; 1x 20,0x38,0; 1x 21,0x38,0
	Belt C Impaktor 0/9 1x 71,0x210,0
	K30 1x 30,0x200,0

8790 HMC HF 1 Zyklop Set tubulare cu antrenare 1/2", cu functie de retinere



Set de 10 piese; intr-o cutie textila de conservare a suprafetei, compacta si extrem de robusta; volum si greutate reduse pentru mobilitate simplificata

10 tubulare Zyklop cu unitate de 1/2" cu functie de retinere. Sistem de identificare scule: codare color si marcaj dimensional pentru a permite ca scula necesara sa fie usor de localizat.

05004203001	
●	8790 HMC HF 1x 10,0x37,0; 1x 11,0x37,0; 1x 12,0x37,0; 1x 13,0x37,0; 1x 14,0x37,0; 1x 15,0x37,0; 1x 16,0x37,0; 1x 17,0x37,0; 1x 18,0x37,0; 1x 19,0x37,0
	K120 1x 50,0x120,0

8740 C HF 2 Zyklop set tubulare bit cu antrenare 1/2", cu functie de retinere



Set de 9 piese; intr-o cutie textila de conservare a suprafetei, compacta si extrem de robusta; volum si greutate reduse pentru mobilitate simplificata

9 tubulare Zyklop, 140 mm lungime, pentru suruburi cap hexagonal, cu actionare de 1/2", cu functie de retinere

05004210001	
○	8740 C HF 1x 4,0x140,0; 1x 5,0x140,0; 1x 6,0x140,0; 1x 7,0x140,0; 1x 8,0x140,0; 1x 10,0x140,0
	K120 1x 50,0x120,0

Belt B VDE 1 Zyklop Set tubulare bit TORX® / hexagonal cu functie de retinere, 3/8"



Set 10 piese; sina textila robusta, inclusiv carabiniera de prindere pentru a permite fixarea sigura la o bucla sau la un buzunar. Benzi scai pentru atasare simpla de ex. la un perete, raft, carucior de scule si la sistemul de transport al sculelor Wera 2go. Mecanism Twist to Unlock (rasuceste pentru deblocare) rapid si usor pentru stocare sigura si extragerea simpla a tubularei.

10 tubulare Zyklop, cu actionare de 3/8". Izolate, testate individual conform IEC 60900. Siguranta sporita datorita izolatiei cu 2 componente cu miez de izolatie galben, care devine vizibila in cazul deteriorarii stratului de izolatie VDE rosu exterior. Functie de retinere pentru suruburile TORX® realizate conform specificatiilor Acument Intellectual Properties si suruburi cu locas hexagonal. Tubulare bit scurte cu beneficiile tehnologiei pentru biti Wera.

05004930001	
♻	8767 B VDE HF 1x TX 20x55,0; 1x TX 25x55,0; 1x TX 27x55,0; 1x TX 30x55,0; 1x TX 40x55,0; 1x TX 45x59,0
○	8740 B VDE HF 1x 4,0x55,0; 1x 5,0x55,0; 1x 6,0x55,0; 1x 8,0x59,0
	Belt B VDE 0/10 1x 71,0x209,0
	K30 1x 30,0x200,0

Belt C Deep 1 set tubulare lungi pe sina textila, 1/2"

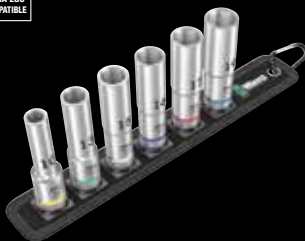

Set de 6 piese; sina textila robusta, inclusiv carabiniera de prindere pentru a permite fixarea sigura la o bucla sau la un buzunar. Benzi scai pentru atasare simpla de ex. la un perete, raft, carucior de scule si la sistemul de transport al sculelor Wera 2go. Mecanism Twist to Unlock (rasuceste pentru deblocare) rapid si usor pentru depozitare sigura si extragerea simpla a tubularelor.

6 tubulare cu actionare de 1/2". Design lung pentru insurubirea suruburilor din alezaje adanci si a tijelor filetate proeminente, cu profil hexagonal. Identificator scule "Take it easy": codare color pentru a permite selectarea usoara a tubularei dorite.

05004565001	
●	8790 HMC Deep 1x 10,0x83,0; 1x 13,0x83,0; 1x 15,0x83,0; 1x 16,0x83,0; 1x 17,0x83,0; 1x 19,0x83,0
	Belt C 0/6 1x 45,0x275,0
	K30 1x 30,0x200,0



Banzi scai practice



Sina textila poate fi atasata prin intermediul benzii scai, de ex. la un perete, raft, carucior de scule si la sistemul de transport al sculelor Wera 2go.

Siguranta sporita



Tubularele Zyklop si extensiile pentru electricieni ofera o siguranta sporita datorita izolarii lor din 2 componente cu miez de izolatie galben sub strat exterior de izolatie rosie.

Kraftform Kompakt W 1 Mentenanta



Setul perfect pentru diverse lucrari de intretinere atat in interior, cat si in exterior - aplicatii: electronica, mecatronica, tehnologie de constructie, fotovoltaic etc. etc.

Maner / Sistem tije interschimbabile – Kraftform Kompakt VDE



Sistemul cu maner / lama interschimbabila permite schimbul rapid al lamelor necesare pentru o gama larga de aplicatii.

Zyklop "6 in 1"



1. Clichet cu dinti fini 2. Clichet cu cap flexibil 3. Clichet cu unghi 4. Clichet cu eliberare rapida 5. Clichet de putere 6. surubelnita

Kraftform Kompakt W 1 Mentenanta



Set de 35 de piese; in cutie textila compacta pentru protectia suprafetei sculelor, foarte robusta; volum si greutate reduse pentru mobilitate simplificata.

Set de scule compacte cu cele mai importante scule de insurubare pentru lucrari de intretinere atat in interior, cat si in exterior. Suport manual surubelnita VDE, incluzand 12 tije VDE; 1 cheie dubla Joker cu functie de retinere, limitator alunecare, unghi mic de retur, dantura fina; incl. clichetul incredibil de rapid de 1/4" Zyklop Speed cu accesorii; 8 tubulare pentru actionare manual si cu masini electrice in dimensiunile 5,5-13, 1 suport universal de biti; 7 biti de 25 mm; 1 accesoriu pentru a tine ferm suruburile pe surubelnita; 1 tester de faza monofazic 247; cutie textila care este foarte robusta si durabila; poate fi pozitionata vertical in raftul atelierului pentru depozitare ordonata; protectie suplimentara a suprafetei datorita materialului exterior textil; greutate si volum redus pentru usurarea mobilitatii.

05135926001		
●	817 VDE	1x 9x102
⊖	KK 60 i	1x 0,4x2,5x154
⊖	KK 60 iS	1x 0,6x3,5x154; 1x 0,8x4,0x154; 1x 1,0x5,5x154
+	KK 62 iS	1x PH 1x154; 1x PH 2x154
+	KK 65 iS PZ	1x PZ 1x154; 1x PZ 2x154
⊗	KK 67 i TORX®	1x TX 10x154
⊗	KK 67 iS	1x TX 15x154; 1x TX 20x154; TORX®
	1440	1x 4,5-6,0x41,0
⊖	247	1x 0,5x3,0x70
	6002 Joker Double	1x 10x13x167
○	8000 A	1x 1/4"x152,0
⊗	8784 A1	1x 1/4"x1/4"x37,0
⊗	8794 SA	1x 1/4"x75,0
⊗	8790 HMA	1x 5,5x23,0; 1x 6,0x23,0; 1x 7,0x23,0; 1x 8,0x23,0; 1x 10,0x23,0; 1x 11,0x23,0; 1x 12,0x23,0; 1x 13,0x23,0
⊗	893/4/1 K	1x 1/4"x50
+	855/1 Z PZ	1x PZ 1x25; 1x PZ 2x25
○	840/1 Z Hex-Plus	1x 3,0x25; 1x 4,0x25; 1x 5,0x25; 1x 6,0x25
⊗	867/1 TORX®	1x TX 25x25
	K240	1x 50,0x240,0

* Produs indisponibil in USA si Canada.

Krafform Kompakt F 1 set scule insurubat pentru instalare ferestre

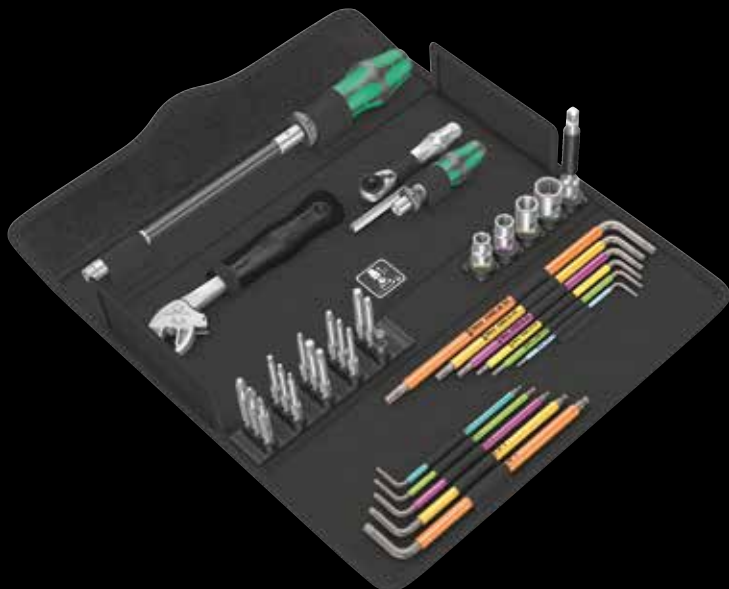

Set de 36 de piese; intr-o cutie textila pentru protejarea suprafetei sculelor, compacta si extrem de robusta. Volum si greutate reduse pentru o mobilitate simplificata.

Set de scule compact pentru instalarea profesionala a ferestrelor. surubelnita 1x 393 S extra subtire cu tija flexibila, cu suport compact din otel inoxidabil si magnet permanent puternic, caracteristica sigura de fixare a bitului datorita mecanismului de blocare, pentru aplicatii in spatii de instalare greu accesibile, 1x suport pentru biti 813, 14 biti, 1x Zyklop Mini 8001 A bit-clichet 1/4", 1x 870/1 adaptor (1/4" -hexagon pana la 1/4" - cap patrat) 1 extensie Zyklop 8794 SA, 1/4", scurta, pentru tubulare bit, 4 Zyklop inserturi tubulare, 2 chei Hex-Plus L pentru suruburi locas hexagonal, 3 chei Hex-Plus L cu functie de retinere pentru suruburi locas hexagonal, 6 chei L cu functie de retinere pentru suruburi TORX®, 1x cheie auto-reglabila 6004 S pentru piulite si suruburi cap hexagonal cu cheie de dimensiunea 10-13 (metrica) sau 7/16" -1/2" (imperiala).

05134013001		
●	393 S	1x 1/4"x173,5
●	813	1x 1/4"x78
○	8001 A	1x 1/4"x87,0
○ ○	870/1	1x 1/4"x25 ¹⁾
● ○	8794 SA	1x 1/4"x75,0
●	8790 HMA	1x 7,0x23,0; 1x 8,0x23,0; 1x 10,0x23,0; 1x 13,0x23,0
+	851/4 TZ PH	1x PH 1x50; 1x PH 2x50; 1x PH 3x50
+	867/4 Z TORX®	1x TX 8x50; 1x TX 10x50; 1x TX 15x50; 1x TX 20x50; 1x TX 25x50; 1x TX 30x50
○	840/4 Z Hex-Plus	1x 2,0x50; 1x 2,5x50; 1x 3,0x50; 1x 4,0x50; 1x 5,0x50; 1x 6,0x89
○	950 SPKL Multicolour	1x 2,0x101; 1x 2,5x112
○	950 SPKL HF Multicolour	1x 3,0x123; 1x 4,0x137; 1x 5,0x154
+	967 SXL TORX® HF Multicolour	1x TX 8x90; 1x TX 10x112; 1x TX 15x123; 1x TX 20x137; 1x TX 25x154; 1x TX 30x195
	6004 Joker S	1x 10-13x7/16"-1/2"x154

¹⁾Cu sfera retinere, pentru tubulare manuale



Set de instrumente pentru constructorul de ferestre profesionist



Set compact de scule de insurubat Wera cu cele mai importante 35 de scule pentru constructia ferestrelor. Cheie tubulare si un sortiment de biti de calitate premium Wera, adaptata aplicatiilor universale de constructie a ferestrelor.

Cu 2 suporturi pentru biti si un clichet bit (care poate fi utilizat

si pentru inserturi tubulare, daca este utilizat cu un adaptor).



Tija flexibila



Insurubare "dupa colt" cu surubelnita 393 S. Arborele flexibil permite atingerea suruburilor de fixare in pozitii nefavorabile. Instrumentul ideal pentru situatii de insurubare greu accesibile.



Set Instalator Kraftform Kompakt SH 2



Set de scule compacte cu cele mai importante 15 instrumente de surubare pentru aplicatii de instalatii sanitare si de incalzire.



Surubelnita tija tubulara



O surubelnita tubulara este necesara ori de cate ori exista lucrari de surubare care implica tije filetate, astfel incat tija filetata poate aluneca prin piulita in capatul tubular

Kraftform Kompakt SH 2 Set instalator



Set de 15 piese; intr-o cutie textila pentru protejarea suprafetei sculelor, compacta si extrem de robusta; volum si greutate reduse pentru mobilitate simplificata.

1 Surubelnita dalta Kraftform 932 A (locas cu crestatura) cu tija hexagonala, cu cap de impact, pentru insurubare si daltuire usoara; 2 surubelnite cu cheie 395 HO cu ax tubular pentru strangerea sau slabirea piulitelor pe tije filetate proeminente, precum si a suruburilor blocate; 1 maner Kraftform Kompakt VDE, 4 tije interschimbabile Kraftform Kompakt VDE cu diametru redus al lamei si izolatie de protectie integrata, astfel incat sa poata fi accesate suruburi in alezaje adanci, testate individual conform IEC 60900; 1 tester de faza monofazic 247, 2 chei combinate cu clichet Joker Switch cu functie de retinere pentru piulite si suruburi cu cap hexagonal, protejand impotriva alunecarii, geometrie dublu hexagonala si dantura extrem de dura pe placa metalica pentru a proteja impotriva alunecarii la cupluri mari, cu un unghi mic de retur de 30°, comutator pentru o schimbare usoara a directiei, capatul inelar inclinat la 15° fata de axa aculei; 4 chei L cu profil Hex-Plus (previne rotunjirea suruburilor cu locas hexagonal), cu functie de retinere pentru suruburi cu locas hexagonal, capat hexagonal sferic pe bratul lung, suprafata BlackLaser, manson din plastic, toate cheile L sunt usor de identificat, codarea lor color si marcaj dimensional.

05136026001		
●	395 HO	1x 10,0x90; 1x 13,0x90
●	932 A	1x 1,2x7,0x125
	6001 Joker Switch	1x 10x159; 1x 13x179
○	950 SPKL HF Multicolour	1x 3,0x123; 1x 4,0x137; 1x 5,0x154; 1x 6,0x172
●	817 VDE	1x 9x102
⊕	KK 62 iS	1x PH 1x154; 1x PH 2x154
⊕	KK 60 iS	1x 0,6x3,5x154; 1x 1,0x5,5x154
●	247	1x 0,5x3,0x70
●	K240	1x 50,0x240,0

Produs indisponibil in USA si Canada.

Kraftform Kompakt H 1 pentru lucrari in lemn



Set de 41 de piese; in cutie textila compacta pentru protectia suprafetei sculelor, foarte robusta; volum si greutate reduse pentru mobilitate simplificata.

Set de scule compacte cu cele mai importante 41 de scule de insurubare pentru lucrari care implica lemn: inclusiv robustul Clichet Bit Zyklop Mini cu extensie si adaptor tubular; 8 tubulare pentru utilizare manuala si pentru scule electrice in dimensiunile 5.5-13; 1 suport manual 816 RA cu functie de clichet, dantura fina pentru unghi mic de retur, inel de comutare (dreapta, fixa, stanga), cuplu maxim 50 Nm si adaptor de biti cu tehnologia Rapidaptor; 1 suport universal de biti; 6 biti de 25 mm lungime; 16 biti de 89 mm lungime; 5 burghie pentru lemn cu diametrele de 3-8mm; 1 accesoriu fixare surub pentru a tine ferm suruburile pe surubelnita; 1 tester de faza monofazic 247; cutie textila foarte robusta si durabila; poate fi pozitionat vertical in raftul atelierului pentru depozitare ordonata; protectie suplimentara a suprafetei datorita materialului exterior textil; greutate si volum redus pentru mobilitate sporita.

05135939001		
●	816 RA	1x 1/4"x142,0
○	8001 A	1x 1/4"x87,0
○	870/1	1x 1/4"x25 ¹⁾
●	8794 SA	1x 1/4"x75,0
●	8790 HMA	1x 5,5x23,0; 1x 6,0x23,0; 1x 7,0x23,0; 1x 8,0x23,0; 1x 10,0x23,0; 1x 12,0x23,0; 1x 13,0x23,0
●	893/4/1 K	1x 1/4"x50
+	851/4 Z PH	1x PH 1x89; 1x PH 2x89; 1x PH 3x89
+	855/4 Z PZ	1x PZ 1x89; 1x PZ 2x89; 1x PZ 3x89
+	855/1 Z PZ	1x PZ 1x25; 1x PZ 2x25; 1x PZ 3x25
⊗	867/4 Z TORX® BO	1x TX 10x89; 1x TX 15x89; 1x TX 20x89; 1x TX 25x89; 1x TX 30x89
⊗	867/1 TORX®	1x TX 20x25; 1x TX 25x25
○	840/4 Z Hex-Plus	1x 3,0x89; 1x 4,0x89; 1x 5,0x89; 1x 6,0x89
⊖	800/4 Z	1x 1,0x5,5x89
⊖	800/1 Z	1x 1,0x5,5x25
⊗	849 HSS	1x 3,0x70,0; 1x 4,0x74,0; 1x 5,0x85,0; 1x 6,0x95,0; 1x 8,0x110,0
⊖	247	1x 0,5x3,0x70
	1441	1x 4,5-6,0x41,0

Kraftform Kompakt M 1 Metal



Set de 39 de piese; in cutie textila compacta pentru protectia suprafetei sculelor, foarte robusta; volum si greutate reduse pentru mobilitate simplificata.

Set de scule compacte cu cele mai importante 39 de scule de insurubare pentru lucrari care implica metal, inclusiv clichetul incredibil de rapid de 1/4" Zyklop Speed cu accesorii; 7 tubulare pentru uz manual si cu masini electrice in dimensiunile 5.5-13; Lungime de 89 mm; 6 biti tarod combinati; 6 burghie pentru metal cu diametrul de 3-10 mm; 1 accesoriu pentru a tine ferm suruburile; 1 tester de faza monofazic 247; cutie textila foarte robusta si durabila; poate fi pozitionata vertical in raftul atelierului pentru depozitare ordonata; protectie suplimentara a suprafetei datorita materialului exterior textil; greutate si volum redus pentru mobilitate usoara.

05135928001		
○	8000 A	1x 1/4"x152,0
○	8794 LA	1x 1/4"x150,0
○	8794 A	1x 1/4"x56,0
●	8784 A1	1x 1/4"x1/4"x37,0
●	816 R	1x 1/4"x119
●	8790 HMA	1x 5,5x23,0; 1x 6,0x23,0; 1x 7,0x23,0; 1x 8,0x23,0; 1x 10,0x23,0; 1x 12,0x23,0; 1x 13,0x23,0
+	851/4 Z PH	1x PH 1x89; 1x PH 2x89; 1x PH 3x89
○	840/4 Z Hex-Plus	1x 3,0x89; 1x 4,0x89; 1x 5,0x89; 1x 6,0x89
⊗	867/4 Z TORX®	1x TX 10x89; 1x TX 15x89; 1x TX 20x89; 1x TX 25x89; 1x TX 30x89
⊖	800/4 Z	1x 1,0x5,5x89
⊗	847 HSS	1x 2,5x36,0; 1x 3,3x39,0; 1x 4,2x41,0; 1x 5,0x44,0; 1x 6,8x51,0; 1x 8,5x59,0
⊗	848 HSS	1x 3,0x38,0; 1x 4,0x44,0; 1x 5,0x50,0; 1x 6,0x50,0; 1x 8,0x51,0; 1x 10,0x54,0
	1441	1x 4,5-6,0x41,0
⊖	247	1x 0,5x3,0x70

¹⁾ Produs indisponibil in USA si Canada.

Bicycle Set Torque 1, 2.5-25 Nm



Set de 16 piese; intr-o cutie textila pentru protectia suprafetei sculelor, compacta si extrem de robusta; volum si greutate reduse pentru mobilitate simplificata.

1 Cheie dinamometrica cu clic-cuplu A 5 cu actionare patrata de 1/4", acoperind un interval de 2,5 Nm-25 Nm, precizie $\pm 4\%$ din valoarea setata, conform DIN EN ISO 6789-1: 2017-07, pentru controlul cuplului in sensul acelor de ceasornic, clichet reversibil, 45 de dinti, reglare usoara si salvarea valorii momentului dorit, cu semnalizare sonora si tactila la atingerea valorilor scalei (scala fina numai in Newton metri), mecanism de declansare sonor si tactil atunci cand valoarea cuplului setata este atinsa, maner ergonomic bicomponent, 4 tubulare Zyklop, cu actionare de 1/4", 4 tubulare Zyklop pentru suruburi TORX®, cu actionare de 1/4", 7 tubulare bit pentru suruburi cu locas hexagonal cu actionare de 1/4" cu functie de retinere; Identificator "Take it Easy"; codarea culorilor pentru a permite selectarea cu usurinta a tubularei bit necesara

05004180001	
	Click-Torque A 5 1x 1/4", 2,5-25 Nm
●	8790 HMA 1x 10,0x23,0; 1x 13,0x23,0; 1x 14,0x23,0; 1x 15,0x23,0
⊗	8767 A 1x TX 10x28,0; 1x TX 20x28,0; 1x TX 25x28,0; 1x TX 30x28,0
○	8740 A HF 1x 3,0x28,0; 1x 4,0x28,0; 1x 5,0x28,0; 1x 5,0x100,0; 1x 6,0x28,0; 1x 6,0x100,0; 1x 8,0x28,0
	K240 1x 50,0x240,0

Bicycle Set 1



Set de 14 piese, in cutie textila; 1 Wera Bit Ratchet Zyklop Mini 1, proiectat complet din otel, potrivit pentru biti hexagonali de 1/4" conform DIN ISO 1173-C 6.3 si E 6.3 si Wera seria 1 si 4; poate fi utilizat si cu 1/4" prize folosind adaptorul de tubulare Wera 870/1; 1 suport universal de biti (100 mm), otel inoxidabil, inel de fixare si magnet permanent puternic; 10 biti, duri, pentru uz universal. 1x mini-levier pentru anvelope 9502 cu locas pentru biti, 1x mini-levier 9503 pentru anvelope cu ejector de supapa.

05004170001	
⊗	8001 A 1x 1/4"x87,0
⊗	3899/4/1 1x 1/4"x100
⊕	851/1 Z PH 1x PH 2x25
⊗	867/1 TORX® 1x TX 10x25; 1x TX 25x25
○	840/1 Z Hex-Plus 1x 2,0x25; 1x 2,5x25; 1x 3,0x25; 1x 4,0x25; 1x 5,0x25; 1x 6,0x25; 1x 8,0x25
	9502 1x 105,0
	9503 1x 105,0
	K70 1x 50,0x70,0



Pentru drum si atelier



Setul de biciclete Torque 1 contine instrumente pentru cele mai populare profiluri de suruburi pentru biciclete de drum, biciclete montane si biciclete electronice. Cu cheia dinamometrica Click-Torque A inclusa (2,5-25 Nm), chiar si asamblarile filetate sensibile la cuplu pot fi slabite si stranse in mod fiabil. Depozitare scula clara si compacta in cutia textila

Bicycle Set 2

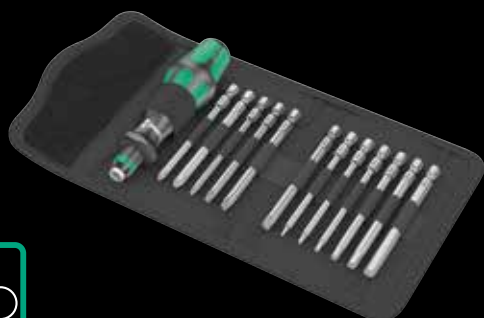

Set de 13 piese, intr-o husa textila; 1 816 R Maner surubelnita Kraftform cu mandrina cu eliberare rapida Rapidaptor, potrivit pentru biti hexagonali de 1/4" conform DIN ISO 1173-C 6.3 si E 6.3 si seria Wera 1 si 4; 12 biti, 89 mm lungime, dur, pentru uz universal

05004171001		
●	816 R	1x 1/4"x119
+	851/4 Z PH	1x PH 1x89; 1x PH 2x89
⊕	867/4 Z TORX®	1x TX 10x89; 1x TX 20x89; 1x TX 25x89; 1x TX 30x89
○	840/4 Z Hex-Plus	1x 2,0x89; 1x 2,5x89; 1x 3,0x89; 1x 4,0x89; 1x 5,0x89; 1x 6,0x89
	K70	1x 50,0x70,0

Bicycle Set 4

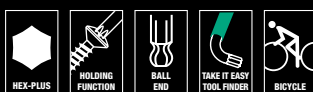

Set de 9 piese in husa textila

Aplicare: Suruburi cu locas hexagonal si suruburi TORX®

Design: Suprafata BlackLaser, manson din plastic durabil. Marcajul contrastant de pe mansonul cu coduri de culoare usureaza recunoasterea dimensiunilor corecte si acest lucru face mai usor sa gasiti instrumentul potrivit.

Varf: 950 SPKL HF: Hex-Plus, hexagon cu sfera pe bratul lung, cu functie de retinere pentru suruburi cu locas hexagonal; 950 SPKL: Hex-Plus, hexagon cu sfera pe brat lung, fara functie de retinere; 967 SXL HF: Cu functie de retinere pentru suruburi TORX® conform specificatiilor Acument Intellectual Properties.

05004173001		
○	950 SPKL Multicolour	1x 2,0x101; 1x 2,5x112
○	950 SPKL HF Multicolour	1x 3,0x123; 1x 4,0x137; 1x 5,0x154; 1x 6,0x172; 1x 8,0x195
⊕	967 SXL TORX® HF Multicolour	1x TX 10x112; 1x TX 25x154
	K70	1x 50,0x70,0

Bicycle Set 3



Set de 41 de piese

28 de biti, 1 suport de mana 813 potrivit pentru atasarea de biti cu actiune hexagonala de 1/4" conform DIN ISO 1173-C 6.3 si conexiune Wera serie 1, 1 suport de biti Rapidaptor, 1 adaptor 870/1 (1/4" hexagon la 1/4" patrat), 7 tubulare (1/4"); 1 Clichet Wera Bit Zyklop Mini 1, construit complet din otel, proiectat pentru fixarea biturilor cu actiune hexagonala de 1/4" conform DIN ISO 1173-C 6.3 si E 6.3 si conexiunile Wera seria 1 si 4; se pot utiliza tubularele 1/4" cu aplicarea adaptorului Wera 870/1. 1 Bit-Check, gol, pentru o selectie redusa de scule, de ex. pentru a participa la tururi cu bicicleta. O husa textila robusta pentru depozitare ordonata. 1x mini-levier pentru anvelope 9502 cu locas pentru biti, 1x mini-levier 9503 pentru anvelope cu ejector de supapa.

05004172001		
□	8001 A	1x 1/4"x87,0
●	813	1x 1/4"x78
○	889/4/1 K	1x 1/4"x50
○	870/1	1x 1/4"x25 ¹⁾
●	8790 HMA	1x 5,5x23,0; 1x 6,0x23,0; 1x 7,0x23,0; 1x 8,0x23,0; 1x 10,0x23,0; 1x 13,0x23,0; 1x 15,0x23,0
+	851/1 TZ PH	1x PH 1x25; 2x PH 2x25; 1x PH 3x25
⊕	867/1 TZ TORX®	1x TX 10x25; 1x TX 15x25; 2x TX 20x25; 2x TX 25x25; 1x TX 27x25; 1x TX 30x25; 1x TX 40x25
⊖	800/1 TZ	1x 0,5x4,0x25; 1x 0,6x4,5x25; 1x 1,0x5,5x25
○	840/1 Z Hex-Plus	1x 2,0x25; 1x 2,5x25; 1x 3,0x25; 1x 4,0x25; 1x 5,0x25; 1x 6,0x25; 1x 8,0x25
○	842/1 Z	1x 2,5x25; 1x 3,0x25; 1x 4,0x25; 1x 5,0x25; 1x 6,0x25
	9502	1x 105,0
	9503	1x 105,0
	K120	1x 50,0x120,0

¹⁾Cu sfera retinere; pentru tubulare manuale



967/9 TX XL Multicolour HF 1 Set chei L cu functie de retinere, lungi



Set de 9 piese intr-un clips cu doua componente

Aplicatii: Suruburi cu locas TORX®

Constructie: Otel acoperit cu manson din plastic durabil, zincat fosfatat. Marcajul contrastant de pe manson cu coduri de culoare usureaza identificarea dimensiunilor corecte si acest lucru face mai usor sa gasiti instrumentul potrivit.

Tip: Functie de retinere a suruburilor TORX® realizate conform specificatiilor Acument Intellectual Properties

967/9 TX HF 1 Set chei L cu functie de retinere, BlackLaser



Set de 9 piese intr-un clip cu doua componente

Aplicatii: Suruburi cu locas TORX®

Constructie: Otel rotund

Tip: Functie de retinere a suruburilor TORX® realizate conform specificatiilor Acument Intellectual Properties, suprafata BlackLaser

05024470001	
	967 SXL TORX® HF Multicolour 1x TX 8x90; 1x TX 9x101; 1x TX 10x112; 1x TX 15x123; 1x TX 20x137; 1x TX 25x154; 1x TX 27x172; 1x TX 30x195; 1x TX 40x224

05024244001	
	967 L TORX® HF 1x TX 8x76; 1x TX 9x79; 1x TX 10x85; 1x TX 15x90; 1x TX 20x96; 1x TX 25x104; 1x TX 27x112; 1x TX 30x122; 1x TX 40x132

3950/9 Hex-Plus Multicolor inoxidabil 1 Set chei hex L, metric, inox



Set de 9 piese intr-un clips bicomponent

Aplicatii: Suruburi cu locas hexagonal

Constructie: Otel inoxidabil cu manson, din plastic durabil. Marcajul evident de pe manson fac usoara recunoasterea dimensiunilor si acest lucru face mai usor sa gasiti instrumentul potrivit.

Varf: Hex-Plus, hexagon cu sfera pe bratul lung

05022669001		
○	3950 SPKL Multicolour	1x 1,5x90; 1x 2,0x101; 1x 2,5x112; 1x 3,0x123; 1x 4,0x137; 1x 5,0x154; 1x 6,0x172; 1x 8,0x195; 1x 10,0x224

950/9 Hex-Plus Multicolour 2 Set chei L, metric, BlackLaser

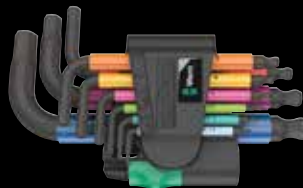

Set de 9 piese intr-un clip cu doua componente

Aplicatii: suruburi cu locas hexagonal

Design: Suprafata Blacklaser, manson din plastic durabil. Marcajul contrastant de pe manson fac usoara recunoasterea dimensiunii corecte si acest lucru face mai usor sa gasiti instrumentul potrivit.

Tip: Hex-Plus, hexagon cu sfera pe bratul lung

05133164001		
○	950 SPKS Multicolour	1x 1,5x50; 1x 2,0x56; 1x 2,5x63; 1x 3,0x71; 1x 4,0x80; 1x 5,0x90; 1x 6,0x100; 1x 8,0x112; 1x 10,0x125

950/9 L Hex-Plus HF 1 Set chei L, metric, cromat, cu functie de retinere



Set de 9 piese intr-un clips cu doua componente

Aplicatii: Suruburi hexagonale

Design: cromat

Tip: Hex-Plus, functie de retinere pentru tubulare hexagon, cap sferic pe bratul lung, dimensiunile: 1,5, 2,0 si 2,5 fara functie de retinere

05022130001		
○	950 L	1x 1,5x90 ¹⁾ ; 1x 2,0x100; 1x 2,5x112
○	950 L HF	1x 3,0x126; 1x 4,0x140; 1x 5,0x160; 1x 6,0x180; 1x 8,0x200; 1x 10,0x219

¹⁾Hexagon normal



Hex-Plus



Suruburile hexagonale pot avea o problema, deoarece suprafetele de contact care furnizeaza puterea de la scula conventionala sunt transferate la surub prin suprafete foarte mici. Consecinta: locasul surubului se poate deteriora (rotunjindu-se). Instrumentele Hex-Plus au o suprafata de contact mai mare

care impiedica acest lucru! in acelasi timp, se poate aplica cuplu cu pana la 20% mai mult. Bine de stiut: sculele Hex-Plus se incadreaza in fiecare surub cu locas hexagonal standard!



Varf sferic



Profilul sferic de antrenare face posibila inclinarea axei sculei fata de axa surubului activand astfel posibilitatea insurubarii la unghi "dupa colt".

950/9 L Hex-Plus 1 SB Set chei L, metric, cromat



Set de 9 piese intr-un clip cu doua componente

Aplicatii: suruburi cu locas hexagonal

Design: cromat

Tip: Hex-Plus, hexagon cu sfera pe bratul lung

		4013288	
05073391001	950 PKL	○ 1x 1.5x90 ¹⁾ ; 1x 2.0x100; 1x 2.5x112; 1x 3.0x126; 1x 4.0x140; 1x 5.0x160; 1x 6.0x180; 1x 8.0x200; 1x 10.0x219	030160

¹⁾ Hexagon normal

950/9 Hex-Plus 6 SB Set chei L, metric, BlackLaser



Set de 9 piese intr-un clip cu doua componente

Aplicatii: suruburi cu locas hexagonal

Design: Suprafata Blacklaser

Tip: Hex-Plus, hexagon cu sfera pe bratul lung

		4013288	
05073596001	950 PKL BM	○ 1x 1.5x90 ¹⁾ ; 1x 2.0x100; 1x 2.5x112; 1x 3.0x126; 1x 4.0x140; 1x 5.0x160; 1x 6.0x180; 1x 8.0x200; 1x 10.0x219	106414

¹⁾ Hexagon normal



Sistem identificare Take it easy



Sistem identificare "Take it Easy" - cu coduri de culoare pentru profil si dimensiune pentru o selectie rapida si usoara a sculelor. Sistem codificare pe culori pentru suruburi locas hexagonal (chei L, tubulare Zyklop), piulite si suruburi cu cap hexagonal (chei Joker, tubulare Zyklop si tubulare Zyklop cu functie de mentinere) si suruburi TORX® (chei L, Tubulare bit Zyklop).

950/9 Hex-Plus Multicolour 1 SB Set chei L, metric, BlackLaser

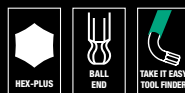

Set de 9 piese intr-un clip cu doua componente

Aplicatii: suruburi cu locas hexagonal

Design: Suprafata Blacklaser, manson din plastic durabil. Marcajul contrastant de pe manson cu coduri de culoare usureaza identificarea dimensiunii corecte si acest lucru face mai usor sa gasiti instrumentul potrivit.

Tip: Hex-Plus, hexagon cu sfera pe bratul lung

		4013288	
05073593001	950 SPKL Multicolour	○ 1x 1,5x90; 1x 2,0x101; 1x 2,5x112; 1x 3,0x123; 1x 4,0x137; 1x 5,0x154; 1x 6,0x172; 1x 8,0x195; 1x 10,0x224	



Wera
BE A TOOL KING

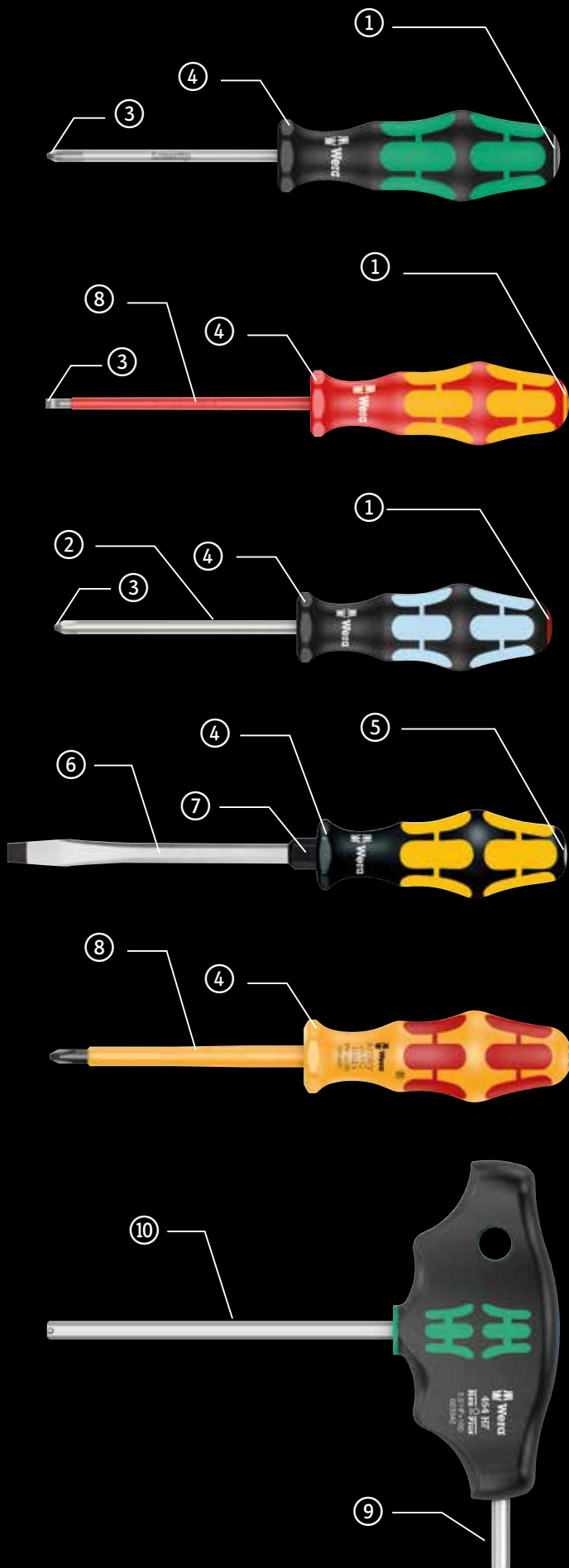

“Take it easy”
Tool Finder



Otel inox cu otel
inox



Lasertip

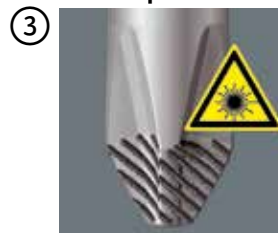

Profil
antirostogolire

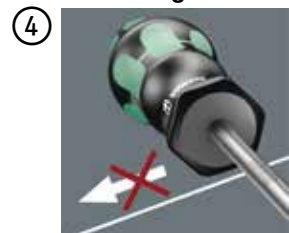

Cap de impact
integrat



Tija prin maner pe
intreaga lungime

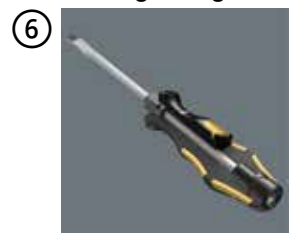

Suport hexagonal
integrat



Testate individual



Brat secundar



Transfer cuplu
mare

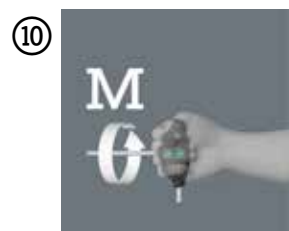

334/6 Set surubelnita Kraftform Plus Lasertip si suport

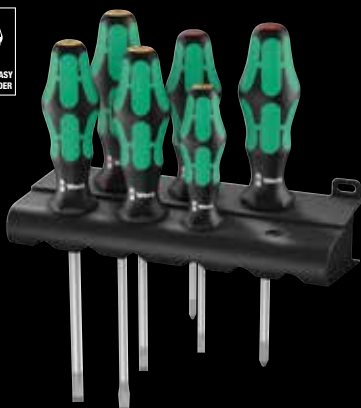

Tije surubelnita rotunde cu varf Lasertip si suport. Take it Easy sistem identificare scule: codificare pe culori in functie de profil si marcaj dimensional.

Aplicatii: Suruburi locas cu crestatura si Phillips

Continut: Set de 6 piese si rack in display carton

05105650001		
+	350 PH	1x PH 1x80; 1x PH 2x100
-	334	1x 1,2x6,5x150
-	335	1x 0,5x3,0x80 ¹⁾ ; 1x 0,8x4,0x100; 1x 1,0x5,5x125

¹⁾Fara Lasertip

Kraftform 300/7 set 1 Set surubelnite Kraftform Plus

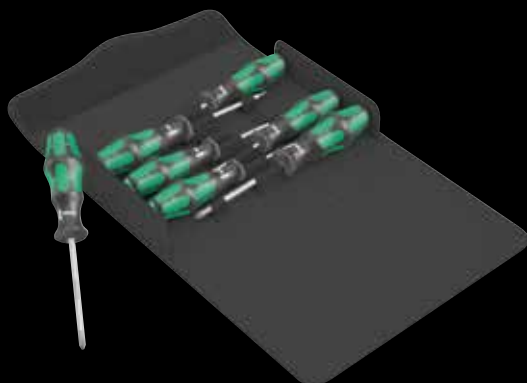

Include cateva surubelnite cu tije rotunde Lasertip. Cu sistem Find it easy : codificare culorilor dupa profiluri si marcaj dimensional.

Aplicatie: Suruburi cu locas cu crestatura, Phillips, Pozidriv si TORX®

Design: Set de 7 piese in cutie compacta, textila, cu compatibilitate Wera 2go

05105623001		
+	350 PH	1x PH 1x80; 1x PH 2x100
+	355 PZ	1x PZ 2x100
+	367 TORX®	1x TX 15x80; 1x TX 20x100; 1x TX 25x100
-	335	1x 0,8x4,0x100
	K240	1x 50,0x240,0



“Take it easy” Tool Finder



Surubelnite cu identicator de scule "Take it Easy": codificare pe culori conform profil si marcaj dimensional.



Previne ranirea mainilor



Designul remarcabil al manerului Kraftform care se potriveste perfect in mana previne ranirea mainilor, cum ar fi bataturi si calusuri.



Lasertip



Un laser cu focalizare precisa creeaza o structura de suprafata cu muchii ascutite. Acest tratament cu laser are ca rezultat o duritate a muchiei de pana la 1000 HV 0,3. Wera Lasertip se „musca” in capul surubului si previne orice alunecare din locas. Este disponibil pentru surubelnite pentru suruburi cu locas cu crestatura, Phillips si Pozidriv.



Profil antirostogolire



Profilul hexagonal non-roll previne orice rostogolire accidentala a sculei la locul de munca.



Durata lunga de viata

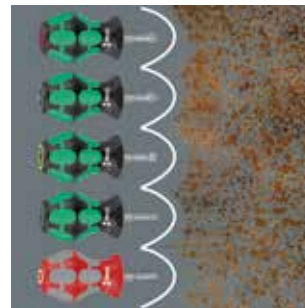

Tratamentul special al suprafetei tijelor asigura un nivel ridicat de protectie impotriva coroziunii si o precizie optima de montare a surubului.

Stubby Set 1 Set surubelnita



Cusistem de identificare scule Find it easy : codarea culori in functie de profil si marcaj dimensional.

Aplicatii: Suruburi locas cu crestatura si Phillips

Design: Set de 5 piese in cutie carton display

05008870001	
	350 PH Stubby 1x PH 1x25; 1x PH 2x25
	335 Stubby 1x 0,6x3,5x24,5; 1x 0,8x4,0x24,5; 1x 1,0x5,5x24,5

“Take it easy” Tool Finder



Surubelnite cu identificator de scule "Take it Easy": codificare pe culori conform profil si marcaj dimensional.

Forma compacta



Cu forma manerului compact si tijascurta, Kraftform Stubbies sunt deosebit de potrivite pentru lucrul in spatii de insurubare restranse.

454/7 Set HF 1 Set de surubelnite cu maner T Hex-Plus cu functie de retinere

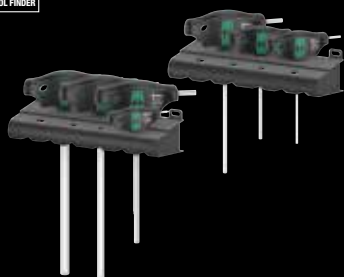

Aplicatii: Suruburi cu locas hexagonal, cu functie de retinere pe bratul lung de dimensiunea 3

Proiectare: Cu instrumentul Find it easy finder: codificare colorilor in functie de profil (albastru = locas hexagonal) si marime. Set de 7 piese si 2 rack-uri in display carton

05023450001		
○	454	1x 2,5x100
○	454 HF	1x 3x100; 1x 4x100; 1x 5x150; 1x 6x150; 1x 8x200; 1x 10x200
	Rack	2x 190,0x50,0

Maner T ergonomic bicomponent



Manerul T bicomponent, cu forma ergonomica, cu degajari pentru degete si o suprafata placuta tactil, faciliteaza transmitia foarte mare a puterii si lucrul fara oboseala.



TORX® HF profil



In situatii de asamblare sau demontare stranse, de exemplu in compartimentele motorului, nu este posibil sa tineti surubul in siguranta cu mana pe surubelnita, iar adesea surubul se pierde. Cautarile indelungate sau pierderea surubului (cu pericolul asociat care ar putea provoca) sunt consecinta.

Instrumentele HF dezvoltate de Wera sunt ideale deoarece au o geometrie optimizata a profilului original TORX®. Fortele de impanare rezultate din presiunea suprafetei dintre varful de actionare si profilul surubului fac ca surubul sa fie tinut in siguranta pe scula!

“Take it easy” Tool Finder



Surubelnite cu identicator de scule "Take it Easy": codificare pe culori conform profil si marcaj dimensional.



Set de surubelnite Rack 160 i/7 Krafftorm Plus seria 100, tester de faza monofazic si rack



Krafftorm: surubelnita de siguranta cu lama Lasertip, tester de faza monofazic si rack. Sistem identificare scule "Take it Easy": codificare culorilor in functie de profil si marcaj dimensiune.

Aplicatii: Suruburi cu locas cu crestatura si Phillips

Constructie: Set de 7 piese si rack in display carton

05006147001	
+	162 i PH VDE 1x PH 1x80; 1x PH 2x100
-	160 i VDE 1x 0,4x2,5x80 ¹⁾ ; 1x 0,6x3,5x100 ¹⁾ ; 1x 0,8x4,0x100; 1x 1,0x5,5x125
-	247 1x 0,5x3,0x70

¹⁾ Fara Lasertip

²⁾ Produs indisponibil in USA si Canada.

Krafftorm 100 iS/7 set 1 Set surubelnita Krafftorm Plus series 100. Partial cu diametru redus al tije

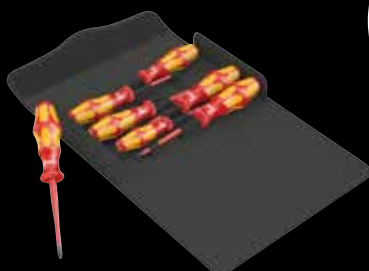

Krafftorm: surubelnita de siguranta. Include cateva surubelnite cu diametrul redus al tije. Cu sistem identificare "Take it Easy": codarea culorilor dupa profiluri si marcaj dimensional.

Aplicatii: Suruburi locas cu crestatura, Phillips, profil combinat Pozidriv / Locas cu crestatura si suruburi TORX®

Constructie: Set de 7 piese in cutie compacta, textila, compatibila cu Wera2go

05136013001	
+	162 iS 1x PH 1x80; 1x PH 2x100
+	165 iS PZ/S 1x # 2x100
+	167 i TORX® VDE 1x TX 20x80; 1x TX 25x100
-	160 iS 1x 0,6x3,5x100; 1x 1,0x5,5x125
-	K240 1x 50,0x240,0

1060 i/1062 i/6 Set de surubelnite de siguranta Krafftorm VDE



Aplicatie: Suruburi cu fante si Phillips

Continut: Set de 6 piese

05051575001	
+	1062 i PH VDE 1x PH 1x80; 1x PH 2x100
-	1060 i VDE 1x 0.4x2.5x80; 1x 0.6x3.5x100; 1x 0.8x4.0x100; 1x 1.0x5.5x125



Testate individual



Surubelnitele noastre sunt testate pentru rezistenta dielectrica sub o sarcina de 10.000 volti pentru a ne asigura ca proprietatea lor cea mai importanta, izolatia lor, a fost testata exhaustiv. Fiecare surubelnita Wera VDE este supusa acestui test pentru a garanta o functionare sigura pana la 1.000 volti.



Repozitionare rapida a mainii



Materialele dure utilizate pentru maner garanteaza ca va puteti schimba rapid aderenta, fara riscul ca pielea sa se „lipeasca” de maner. Zonele mai moi, "antiderapante" permit transmiterea cu pierderi reduse a cuplurilor ridicate.



3334/6 Set de surubelnite, inox si rack



Aplicatii: Suruburi drepte/locas cu crestatura si Phillips

Continut: Set de 6 piese cu sistem Find it easy: codare color in functie de profil si marcaj dimensional plus suport in display carton

05032060001		
+	3350 PH	1x PH 1x80; 1x PH 2x100
-	3335	1x 0,5x3,0x80 ¹⁾ ; 1x 0,8x4,0x100; 1x 1,0x5,5x125
-	3334	1x 1,2x6,5x150

¹⁾Fara Lasertip



Otel inox cu otel inox



Solutia la problema ruginirii prin contaminare: otel inox din surub versus otel inox din scula de insurubat! Sculele Wera Inox sunt produse din otel inox si astfel rugina deranjanta vizuala poate fi eliminata.

Durificat in vid



Uneltele din otel inoxidabil de la Wera sunt durificate sub cu vid si au duritatea si rezistenta necesare pentru conexiunile cu surub. Nu exista limitari ale aplicatiilor industriale pentru care sunt potrivite.

932/6 Set surubelnite impact/dalta Wera Kraftform cu suport



Aplicatie: Suruburi locas cu crestatura si Phillips

Continut: Set de 6 piese in display carton

05018282001		
+	917 SPH	1x PH 1x80; 1x PH 2x100
-	932 A	1x 0,6x3,5x80 ¹⁾ ; 1x 0,8x4,5x90; 1x 1,0x5,5x100; 1x 1,2x7,0x125

¹⁾Fara tija continua prin maner, fara cap lovire si fara antrenare hexagonala pe tija pentru cheie

Kraftform 900/7 set 1 Set surubelnite impact Kraftform Wera: Surubelnita delta

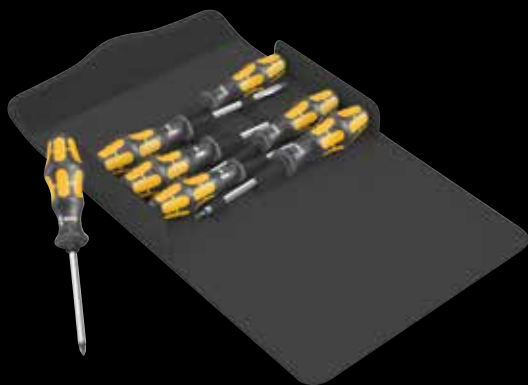

Aplicatii: Suruburi cu locas cu crestatura, Phillips si TORX®

Design: Set de 7 bucati in cutie compacta, textila, cu compatibilitate Wera2go

05137811001		
+	917 SPH	1x PH 1x80; 1x PH 2x100
+	977 TORX®	1x TX 20x90; 1x TX 25x100
-	932 A	1x 0,8x4,5x90; 1x 1,0x5,5x100; 1x 1,2x7,0x125
	K240	1x 50,0x240,0



Cap de impact integrat



Un cap de impact integrat prelungeste durata de viata si reduce pericolul de aschiere. Cu toate acestea, purtati intotdeauna ochelari de protectie.



Tija prin maner pe intreaga lungime



O lama hexagonala din material de inalta calitate, se extinde chiar prin maner - asigurand astfel transferul complet de forta, chiar si atunci cand este lovit cu un ciocan. Materialul ductil temperat impiedica taierea sau ruperea lamei.



Suport hexagonal integrat



Cheia hexagonala integrata poate fi utilizata pentru a transmite cupluri mai mari cu o cheie fixa sau inelara.



Varf Wera Black Point



Varful Wera Black Point si un proces de durificare rafinat asigura o durata lunga de viata a varfului, o protectie imbunatatita impotriva coroziunii si o potrivire exacta.



Kraftform Micro 12 Universal 1 Set surubelnita pentru aplicatii electronice

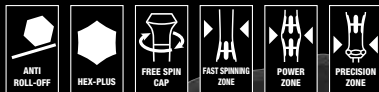

Take it Easy: codare culori in functie de profil si marime.

Aplicatii: Suruburi cu locas cu crestatura, Phillips, TORX® si hexagonale

Continut: Set de 12 piese, intr-o husa textila pentru curea

05073675001	
+	2050 PH Micro 1x PH 00x60 ¹⁾ ; 1x PH 0x60 ²⁾
⊕	2067 TORX® HF 1x TX 5x40; 1x TX 6x40
⊖	2035 Micro 1x 0,23x1,5x40; 1x 0,30x1,8x60; 1x 0,40x2,0x60; 1x 0,40x2,5x80; 1x 0,50x3,0x80
○	2054 Micro 1x 0,9x40; 1x 1,5x60; 1x 2x60 K70 1x 50,0x70,0

¹⁾Optimize pentru suruburi PH asiatice

²⁾Marimea 0 modificata conform JCS 0 (Japanese Camera Industrial Standard)



"Take it easy" Tool Finder

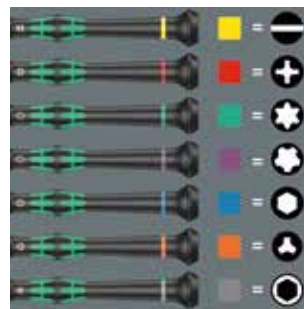

Surubelnite cu identicator de scule "Take it Easy": codificare pe culori conform profil si marcaj dimensional.



Surubelnita rafinata pentru electronisti



Kraftform Micro, cu cele trei zone ale sale si disponerea lor specifica, satisface perfect aceste cerinte. Capul de rotire libera care ofera suport pentru mana functioneaza cu aceste avantaje, permitand o lucrare de precizie rapida si usoara.

Kraftform Kompakt Micro 11 Universal 1



Set de 11 piese

Cutie textila cu biti de 44 mm

1 Kraftform Micro bitholding screwdriver 1013

05135938001		
⊕	1013 Kraftform Micro	1x 97
+	851/9 C	1x PH 00x44 ¹⁾ ; 1x PH 0x44 ²⁾ ; 1x PH 1x44 ¹⁾
○	840/9 C	1x 1,5x44; 1x 2,0x44
⊖	800/9 C	1x 0,23x1,5x44; 1x 0,40x2,0x44; 1x 0,50x3,0x44
⊕	867/9 C TORX®	1x TX 5x44; 1x TX 6x44

¹⁾Optimize pentru suruburi PH asiatice

²⁾Marimea 0 modificata conform JCS 0 (Japanese Camera Industrial Standard)

Set surubelnite Micro Big Pack 1 pentru aplicatii electronice



Take it Easy - identificare scule: codificare culoril in functie de profil si marime.

Aplicatii: Suruburi cu locas cu crestatura, cap Phillips, Phillips-Recess, traductoare interne TORX® (TX 5, TX 6, TX 7, TX 8, TX 10 cu functie de mentinere), IPS intern TORX PLUS®, suruburi hexagonale interne si externe si suruburi Microstix®, 1 chip lifter (furculita chipuri) pentru a indeparta componentele blocate de pe placile de circuite dupa lipire

Continut: 25 de piese; in husa textila; potrivit pentru Wera 2go

05134000001	
+	2050 PH Micro 1x PH 000x40 ^{1) 2)} ; 1x PH 00x40 ^{1) 2)} ; 1x PH 0x40 ³⁾
+	2067 TORX® 1x TX 5x40; 1x TX 6x40
+	2067 TORX® HF 1x TX 5x40; 1x TX 6x40; 1x TX 7x60; 1x TX 8x60; 1x TX 10x60
+	2067 TORX PLUS® IPR Micro 1x 1 IPRx40 ⁴⁾
○	2054 Micro 1x 0,9x40; 1x 1,3x40; 1x 1,5x60; 1x 2x60
⊖	2035 Micro 1x 0,23x1,5x40; 1x 0,30x1,8x60; 1x 0,35x2,5x40; 1x 0,40x2,0x60; 1x 0,40x2,5x80; 1x 0,50x3,0x80
●	2069 Micro 1x 4,0x60; 1x 5,5x60
⊕	2072 1x mx40
●	1429 1x 1,0x3,5x50
	K240 1x 50,0x240,0

¹⁾Optimizate pentru suruburi PH asiatice

²⁾Pe suprafata de lucru tija este strunjita la o lungime nominala de 10 mm

³⁾Marimea 0 modificata conform JCIS 0 (Japanese Camera Industrial Standard)

⁴⁾Fara gaura

2035/6 A Set de surubelnite si rack pentru aplicatii electronice



Sistem identificare scule "Take it Easy": codificare culorilor in functie de profil si marcaj dimensiune.

Aplicatii: suruburi cu locas cu crestatura si Phillips

Continut: Set de 6 piese si rack in display carton

05118150001	
+	2050 PH Micro 1x PH 00x60 ¹⁾ ; 1x PH 0x60 ²⁾
⊖	2035 Micro 1x 0,30x1,8x60; 1x 0,40x2,0x60; 1x 0,40x2,5x80; 1x 0,50x3,0x80

¹⁾Optimizate pentru suruburi PH asiatice

²⁾Marimea 0 modificata conform JCIS 0 (Japanese Camera Industrial Standard)

Kit de reparare smartphone Kraftform Micro 6 ESD 1



Cu Take it easy Tool Finder: codificare pe culori dupa profil si marcaj dimensional.

Aplicatie: Suruburi locas Phillips, TORX PLUS® IPR si Microstix®, 1 furca de ridicare pentru indepartarea componentelor blocate pe placile de circuite imprimate dupa dezlipire

Design: Set de 6 piese intr-o cutie de carton + suport

05030182001	
+	1550 PH ESD Micro 1x PH 00x40 ^{1) 2)} ; 1x PH 0x40 ³⁾
+	1567 TORX PLUS® IPR ESD 1x 1 IPRx40 ⁴⁾
⊕	1572 ESD 1x mx40
+	1550 PH S ESD Micro 1x # 01x40
●	1529 ESD 1x 1.0x3.5x50

¹⁾Optimizate pentru suruburi PH asiatice

²⁾Pe suprafata de lucru tija este strunjita la o lungime nominala de 10 mm

³⁾Marimea 0 modificata conform JCIS 0 (Japanese Camera Industrial Standard)

⁴⁾Fara gaura



Click-Torque A 5 cheie dinamometrica cu clichet reversibil, 2,5-25 Nm



Aplicatie: pentru controlul cuplului in sensul acelor de ceasornic

Precizie: ± 4% din valoarea setata, conform DIN EN ISO 6789-1: 2017-07

Design: Cu antrenare patrata de 1/4", clichet reversibil, 45 de dinti; setarea si salvarea usoara a valorii de cuplu dorita, cu semnalizare sonora si tactila la atingerea valorilor scalei (scara fina doar in Newtoni metri) , mecanism de declansare sonor si tactil atunci cand valoarea cuplului setata este atinsa

Maner: Maner ergonomic din 2 componente

	Nm	Nm	lbf. ft.	mm	mm	mm	mm	mm	mm	mm	mm	mm		
05075604001	1/4"	2.5-25	0.10	1-18	290	121	42	25	11,5	11 27/64"	4 49/64"	1 21/32"	1"	7/16"

Click-Torque A 6 cheie dinamometrica cu clichet reversibil, 2,5-25 Nm



Aplicatie: pentru controlul cuplului in sensul acelor de ceasornic

Precizie: ± 4% din valoarea setata, conform DIN EN ISO 6789-1: 2017-07

Design: Cu antrenare hexagonala de 1/4", clichet reversibil, 45 de dinti; setarea si salvarea usoara a valorii de cuplu dorita, cu semnalizare sonora si tactila la atingerea valorilor scalei (scara fina doar in Newtoni metri) , mecanism de declansare sonor si tactil atunci cand valoarea cuplului setata este atinsa

Maner: Maner ergonomic din 2 componente

	Nm	Nm	lbf. ft.	mm	mm	mm	mm	mm	mm	mm	mm	mm		
05075605001	1/4"	2.5-25	0.10	1-18	290	121	42	25	11,5	11 27/64"	4 49/64"	1 21/32"	1"	7/16"

Click-Torque A 6



Cu antrenare hexagon 1/4".

Mecanism de eliberare



Cand se atinge valoarea setata a cuplului, se declanseaza un mecanism sonor si tactil.

Cheie dinamometrica Click-Torque B 1 cu clichet reversibil, 10-50 Nm



Aplicatie: pentru controlul cuplului in sensul acelor de ceasornic

Precizie: ±3% din valoarea setata, conform DIN EN ISO 6789-1: 2017-07

Design: Cu antrenare patrata de 3/8", clichet reversibil, 45 de dinti; setarea si salvarea usoara a valorii de cuplu dorita, cu semnalizare sonora si tactila la atingerea valorilor scalei (scara fina doar in Newtoni metri), mecanism de declansare sonor si tactil atunci cand valoarea cuplului setata este atinsa

Maner: Maner ergonomic din 2 componente

		Nm	Nm	lbf. ft.	mm	mm	mm	mm	mm					
05075610001	3/8"	10-50	0.25	8-36	360	140	47	35	16,5	14 11/64"	5 33/64"	1 27/32"	1 3/8"	5/8"
		Nm	Nm	lbf. ft.	mm	mm	mm	mm	mm					
05075611001	3/8"	20-100	0.5	15-73	405	140	47	43	18,5	15 15/16"	5 33/64"	1 27/32"	1 11/16"	45/64"
		Nm	Nm	lbf. ft.	mm	mm	mm	mm	mm					
05075620001	1/2"	10-50	0.25	8-36	360	140	47	35	16,5	14 11/64"	5 33/64"	1 27/32"	1 3/8"	5/8"
		Nm	Nm	lbf. ft.	mm	mm	mm	mm	mm					
05075621001	1/2"	20-100	0.5	15-73	405	140	47	43	18,5	15 15/16"	5 33/64"	1 27/32"	1 11/16"	45/64"
		Nm	Nm	lbf. ft.	mm	mm	mm	mm	mm					
05075622001	1/2"	40-200	1.0	30-146	510	140	47	43	18,5	20 5/64"	5 33/64"	1 27/32"	1 11/16"	45/64"
		Nm	Nm	lbf. ft.	mm	mm	mm	mm	mm					
05075623001	1/2"	60-300	1.0	45-220	595	140	47	43	18,5	23 27/64"	5 33/64"	1 27/32"	1 11/16"	45/64"

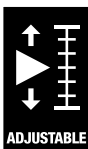

Setare usoara



Cu click-uri tactile si audibile la reglarea valorilor cuplului.

Mecanism de eliberare



Cand se atinge valoarea setata a cuplului, se declanseaza un mecanism sonor si tactil.

Click-Torque C 2 Push R/L cheie dinamometrica reglabila pentru controlul cuplului in sensul acelor de ceasornic si in sens invers acelor de ceasornic, 20-100 Nm



Aplicatie: Pentru controlul cuplului in sensul acelor de ceasornic si in sens invers acelor de ceasornic

Precizie: Precizie $\pm 3\%$ din valoarea setata, conform DIN EN ISO 6789-1: 2017-07

Design: Cu antrenare cu cap patrat de 1/2 inch cu blocarea tubularelor, Patrat push-through pentru a schimba directia de antrenare, mecanism clichet cu dantura fina, 45 de dinti; setare si salvarea usoara a cuplului dorit, cu avertizare sonora si tactila la atingerea valorilor setate (scara fina doar in Newtoni metri), mecanism de declansare cu avertizare sonora si tactila la atingerea valorii cuplului

Maner: Ergonomic Maner cu 2 componente

		Nm	Nm	lbf. ft.	mm	mm	mm	mm	mm					
05075625001	1/2"	20-100	0.5	15-73	405	140	47	43	18,5	15 15/16"	5 33/64"	1 27/32"	1 11/16"	45/64"

		Nm	Nm	lbf. ft.	mm	mm	mm	mm	mm					
05075626001	1/2"	40-200	1.0	30-146	510	140	47	43	18,5	20 5/64"	5 33/64"	1 27/32"	1 11/16"	45/64"

		Nm	Nm	lbf. ft.	mm	mm	mm	mm	mm					
05075631001	3/4"	200-1000	1.0	148-737	1250	140	47	63	30	49 7/32"	5 33/64"	1 27/32"	2 31/64"	1 3/16"

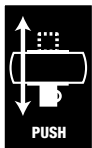

Operare stanga - dreapta



Cheia dinamometrică Click-Torque este potrivită pentru controlul cuplului în sensul acelor de ceasornic și în sens invers acelor de ceasornic. Schimbare foarte lină de direcție datorită inserției pătrate.

Surubelnite dinamometrice reglabile Kraffform din seria 7400 (0,1-3,0 Nm) cu mandrina cu eliberare rapida Rapidaptor



Aplicatie: Potrivit pentru insertii hexagonale de 1/4" DIN ISO 1173-C 6.3 si E 6.3 si Wera Series 1 si 4

Design: Rapidaptor tehnologie rapid-in , rapid-out, rapid-spin, chuck-all si cu o singura mana

Precizie: ±6 % (DIN EN ISO 6789). Scala numerica pentru cuplu. Mecanism de reglare fiabil si semnal acustic la atingerea cuplului setat.

Maner: Kraffform cu caracteristica anti-rulare, multicomponent

	Art.No.						
		Nm	Nm	mm	mm	mm	mm
05074770001 ¹⁾	7430	1/4"	0.10-0.34	0.015	89	142	5 7/16"
05074772001 ¹⁾	7431	1/4"	0.30-1.00	0.05	89	142	5 7/16"
05074774001 ¹⁾	7432	1/4"	0.90-1.50	0.05	89	142	5 7/16"
05074700001	7440	1/4"	0.3-1.2	0.05	105	155	6"
05074701001	7441	1/4"	1.2-3.0	0.10	105	155	6"

¹⁾Cu lupă atașabilă, îmbunătățind sensibilitatea vizibilității.

Surubelnite dinamometrice reglabile din seria 7400 Kraffform presetate (0,3-3,0 Nm) cu mandrina cu eliberare rapida Rapidaptor, dimensiune maner 105 mm



Aplicatie: Potrivit pentru insertii hexagonale de 1/4" DIN ISO 1173-C 6.3 si E 6.3 si Wera Series 1 si 4

Design: Rapidaptor rapid-in , eliberare rapida, rotire rapida, mandrina chuck all si tehnologie pentru utilizare cu o singura mana

Cuplu presetat: 0,3 Nm, 1,2 Nm

Precizie: ± 6% (DIN EN ISO 6789). Mecanism de reglare fiabil si semnal acustic la atingerea cuplului setat.

Maner: Kraffform cu caracteristica anti-ruliu, multicomponent

	Art.No.						
		Nm	Nm	mm	mm	mm	mm
05074715001	7460	1/4"	0.3	0.3-1.2	105	155	6"
05074716001	7461	1/4"	1.2	1.2-3.0	105	155	6"

Surubelnite dinamometrice reglabile (3,0-8,8 Nm) cu maner tip pistol Kraffform seria 7400 si cu mandrina cu eliberare rapida Rapidaptor



Aplicatie: Potrivit pentru insertii hexagonale de 1/4" DIN ISO 1173-C 6.3 si E 6.3 si Wera Series 1 si 4

Design: Rapidaptor rapid-in , tehnologia de eliberare rapida, de rotire rapida, chuck all si cu o singura mana

Precizie: ±6 % (DIN EN ISO 6789). Scala numerica pentru valorile cuplului. Mecanism de reglare si acustic fiabil. Semnal acustic la atingerea cuplului setat.

Maner: Maner tip pistol Kraffform, multicomponent

	Art.No.						
		Nm	Nm	mm	mm	mm	mm
05074702001	7442	1/4"	3.0-6.0	0.25	150	100	4"
05074705001	7443	1/4"	4.0-8.8	0.40	150	100	4"

Surubelnite dinamometrice din seria 7400 Kraffform cu o valoare de masurare personalizata presetata din fabrica, dimensiunea manerului 105 mm



	Art.No.					
		Nm	mm	mm	mm	mm
05074715010	7460	1/4"	0.3-1.2	105	155	6"
05074716010	7461	1/4"	1.2-3.0	105	155	6"

Surubelnite dinamometrice reglabile din seria 7400 Kraftform presetate (0,1-1,5 Nm) cu mandrina cu eliberare rapida Rapidaptor, dimensiunea manerului 89 mm



Aplicatie: Potrivit pentru insertii hexagonale de 1/4" DIN ISO 1173-C 6.3 si E 6.3 si Wera Series 1 si 4

Design: Rapidaptor rapid-in , eliberare rapida, rotire rapida, mandrina chuck all operare cu o singura mana

Cuplu presetat: 0,1 Nm, 0,3 Nm, 0,9 Nm

Precizie: ± 6% (DIN EN ISO 6789). Mecanism de reglare fiabil si semnal acustic la atingerea cuplului setat.

Maner: Kraftform cu caracteristica anti-rolare, multicomponent

	Art.No.	Nm	Nm	mm	mm	mm
05074790001	7450	1/4"	0.1 0.1-0.34	89	133	5 1/4"
05074792001	7451	1/4"	0.3 0.3-1.0	89	133	5 1/4"
05074794001	7452	1/4"	0.9 0.9-1,5	89	133	5 1/4"

Surubelnite dinamometrice din seria 7400 Kraftform cu o valoare de masurare personalizata presetata din fabrica, dimensiunea manerului 89 mm



	Art.No.	Nm	mm	mm	mm
05074790010	7450	1/4" 0.1-0.34	89	133	5 1/4"
05074792010	7451	1/4" 0.3-1.0	89	133	5 1/4"
05074794010	7452	1/4" 0,9-1,5	89	133	5 1/4"

Surubelnite dinamometrice reglabile cu maner tip pistol Kraftform seria 7400 presetate (3,0-8,8 Nm) cu mandrina cu eliberare rapida Rapidaptor



Aplicatie: Potrivit pentru insertii hexagonale de 1/4" DIN ISO 1173-C 6.3 si E 6.3 si Wera Seria 1 si 4

Design: Rapidaptor rapid-in , tehnologia de eliberare, rotire rapida, mandrina universala si tehnologie operare cu o singura mana

Cuplu presetat: 3,0 Nm, 4,0 Nm

Precizie: ±6 % (DIN EN ISO 6789). Mecanism de alunecare fiabil si semnal acustic la atingerea cuplului setat.

Maner: Maner pistol Kraftform, multicomponent

	Art.No.	Nm	Nm	mm	mm	mm	mm
05074717001	7462	1/4"	3.03.0-6.0	150	100	6"	4"
05074728001	7463	1/4"	4.04.0-8.8	150	100	6"	4"

Surubelnite dinamometrice din seria 7400 Kraftform cu o valoare de masurare personalizata presetata din fabrica, maner tip pistol



	Art.No.	Nm	mm	mm	mm	mm
05074717010	7462	1/4" 3.0-6.0	150	100	6"	4"
05074728010	7463	1/4" 4.0-8.8	150	100	6"	4"

Ce tip de bit este potrivit pentru o anumită lucrare?



Bituri Impaktor



sunt necesare când se utilizează o unelată electrică puternică (ex. șurubelniță cu impact de 18 volți). Capetele de impact au fost dezvoltate special pentru a rezista la forțele mai ridicate ale sculelor electrice.



Inoxidabile



Prin utilizarea capetelor din oțel inoxidabil, se previne formarea ruginii pe șuruburile sau suprafețele din oțel inoxidabil. Rugina pe oțelul inoxidabil apare în principal din cauza particulelor de material uzat care rămân după lucrarea de înșurubare în cazul uneltelor din oțel convențional. Astfel de particule de oțel uzat aderă la șurub și încep să ruginească sub influența oxigenului și a umezelii. Acestea sunt ușor regnoscibile datorită banderolei albastre.



Bituri BDC



sunt produse de calitate superioară. Acestea au o zonă BiTorsion mai moale care reduce duritatea tijeii cu cca 20 % în comparație cu vârful. Aceasta înseamnă că sarcinile maxime care cauzează ruperea capetelor sunt absorbite în această zonă – aspect care prelungeste durata de viață a capetelor. Acoperirea diamantată reduce pericolul de alunecare deoarece particule minuscule de diamant „mușcă” literalmente în capul șurubului. B semnifică BiTorsion. DC semnifică acoperire diamantată.

Bituri Z



sunt bituri ductile, rezistente pentru materiale dure precum tabla din oțel sau metalul.



Bituri TZ



sunt capete Z cu o zonă de torsiune. Bituri de torsiune absorb sarcinile maxime nocive în zona de torsiune. Astfel se previne uzura prematură și se îmbunătățește durata de viață a capetelor.



Bituri BTZ



au o zonă călită suplimentară. BiTorsion, care reduce duritatea tijeii cu cca 20 % în comparație cu vârful șurubelniței. Aceasta înseamnă că sarcinile maxime care cauzează ruperea biturilor sunt absorbite în această zonă – aspect care prelungeste durata de viață a capetelor.

Bituri H



sunt capete deosebit de dure pentru materiale semidure, precum lemnul.



Bituri TH



sunt capete H cu o zonă de torsiune. Capetele de torsiune absorb sarcinile maxime nocive în zona de torsiune. Astfel se previne uzura prematură și se îmbunătățește durata de viață a capetelor.



Bituri BTH



au o zonă călită suplimentară BiTorsion, care reduce duritatea tijeii cu cca 20 % în comparație cu vârful șurubelniței. Aceasta înseamnă că sarcinile maxime care cauzează ruperea capetelor sunt absorbite în această zonă – aspect care prelungeste durata de viață a capetelor.

Bituri A



A semnifică aviație. Capetele A sunt deosebit de dure cu un profil cu muchie ascuțită care, de exemplu, penetrează profilurile de șuruburi pline de vopsea (cum ar fi pe panourile de fuselaj), asigurând astfel un transfer corect al forței între cap și șurub.

Bituri J



J semnifică Japonia. Capetele J au fost optimizate pentru a corespunde șuruburilor PH asiatice. În special, sunt destinate utilizării cu piese de dimensiuni foarte reduse după cum se stipulează în standardul japonez pentru camere video.

Bituri ACR®



Capete ACR®. ACR® semnifică „nervuri antiderapante”. Capetele ACR® sunt prevăzute cu nervuri în vârf care protejează contra alunecării din capul șurubului. Se recomandă utilizarea capetelor ACR® cu șuruburi cu nervuri ACR® pentru efect maxim. ACR® este marcă înregistrată a Phillips Screw Company.



Bituri TiN



TiN semnifică nitrit de titan. O acoperire extrem de dură pentru a rezista unor sarcini premanente cum ar fi în timpul operațiilor de înșurubare din producția de serie.

Adaptoare pentru bituri

Suport 897/4 IMP Impaktor cu inel de reținere și magnet inelar



Suport Impaktor pentru amortizarea sarcinilor maxime, efect de torsiune special de la arcul cu dublă torsiune, dotat cu un inel de reținere pentru o fixare sigură a capetelor în suport, suport din oțel inoxidabil, dotat cu magnet inelar pentru poziționare sigură a capului și a șurubului.

Suport de cap universal 897/4 R Rapidaptor BiTorsion



Adecvat pentru capete cu tijă hexagonală 1/4"
DIN 3126-C 6,3 și E 6,3 (ISO 1173) și Wera seriile 1 și 4

Suport de cap universal 887/4 RR Rapidaptor cu magnet inelar



Adecvat pentru capete cu tijă hexagonală 1/4"
DIN 3126-C 6,3 și E 6,3 (ISO 1173) și Wera seriile 1 și 4

Suport de cap universal 889/4/1 K Rapidaptor



Adecvat pentru capete cu tijă hexagonală 1/4"
DIN 3126-C 6,3 și E 6,3 (ISO 1173) și Wera seriile 1 și 4

Suport de cap universal 894/4/1 K



Adecvat pentru capete cu tijă hexagonală 1/4"
DIN 3126-C 6,3 (ISO 1173) și Wera seria 1

Suport de cap universal 893/4/1 K



Adecvat pentru capete cu tijă hexagonală 1/4"
DIN 3126-C 6,3 (ISO 1173) și Wera seria 1



889/4/1 F Rapidaptor suport bit liber rotitor pentru surubelnite dinamometrice cu maner tip pistol



Antrenare: Pentru biti cu 1/4"-antrenare hexagonala externa conform DIN ISO 1173-C 6.3 si E 6.3 si conexiuni Wera seria 1 si 4

Constructie: Cu functie de rotire libera pentru o miscare de intoarcere deosebit de rapida, fara a fi nevoie sa scoateti surubelnita atunci cand strangeti suruburile. Potrivit in special pentru aplicatiile cu surubelnite dinamometrice Wera cu maner pistol in gama 7400. Tehnologie Rapidaptor cu intrare rapida, iesire rapida, cu rotire rapida, cu mandrina si functii cu o singura mana, cu magnet permanent puternic

Unitate: 1/4"-hexagon, potrivit pentru montare conform DIN ISO 1173-F 6.3

	mm	mm	mm	mm	mm
05052501001	1/4"	64	2 33/64"	1/4"	16,5

Bit-Check 6 Impaktor 1



6 biti Impaktor. Bit-Check-urile "Take it easy" au biti cu mansoa plastic colorat si marcaj dimensional care faciliteaza accesarea rapida a bitului potrivit.

05057695001	
+	851/4 IMP DC 1x PH 2x50; 1x PH 3x50
+	855/4 IMP DC 1x PZ 2x50; 1x PZ 3x50
+	867/4 IMP DC 1x TX 25x50; 1x TX 30x50

Magnetic



Suporturi magnetice, pentru o aplicare mai usoara a surubului



Zona de torsiune



Zona de torsiune special conceputa pentru a absorbi astfel de forte si a proteja astfel varful bitului.



Biti impaktor



Bitii de impact sunt necesari atunci cand se utilizeaza un instrument electric puternic. Bitii de impact au fost special conceputi pentru a rezista fortelor mari ale sculelor electrice.

La locul de munca



Bit-Check-urile pot fi pozitionate vertical la locul de munca, astfel incat sa fie intotdeauna la indemana.

Bit-Check 12 BiTorsion 1



Suport Rapidaptor cu 1 bit cu mandrina cu eliberare rapida, 11 biti BiTorsion cu durata lunga de viata, duri, pentru utilizare universala. Bit-Check-urile "Take it easy" au biti cu manson plastic colorat si marcaj dimensional care faciliteaza accesarea rapida a bitului potrivit.

05057420001		
⊙ ⊙	889/4/1 K	1x 1/4"x50
+	851/1 BTZ PH	1x PH 1x25; 2x PH 2x25
+	855/1 BTZ PZ	1x PZ 1x25; 2x PZ 2x25
⊙	867/1 TORX® BTZ	1x TX 10x25; 1x TX 15x25; 1x TX 20x25; 1x TX 25x25; 1x TX 30x25

Bit-Check 30 Universal 1



Suport Rapidaptor 1 bit cu mandrina cu eliberare rapida, 29 biti, design in de torsiune (T) pentru a reduce uzura prematura, dura (Z), pentru utilizare universala, extra-dura (H).

05056440001		
⊙ ⊙	889/4/1 K	1x 1/4"x50
+	851/1 TZ PH	2x PH 1x25; 3x PH 2x25; 1x PH 3x25
+	855/1 TH PZ	2x PZ 1x25; 3x PZ 2x25; 1x PZ 3x25
⊙	867/1 TZ TORX®	1x TX 10x25; 1x TX 15x25; 1x TX 20x25; 1x TX 25x25; 1x TX 30x25; 1x TX 40x25
⊙	867/1 Z TORX® BO	1x TX 10x25; 1x TX 15x25; 1x TX 20x25; 1x TX 25x25; 1x TX 30x25
⊙	800/1 TZ	1x 1,0x5,5x25
⊙	840/1 Z Hex-Plus	1x 3,0x25; 1x 4,0x25; 1x 5,0x25; 1x 6,0x25; 1x 8,0x25

Set de scule pentru constructii terase T 1

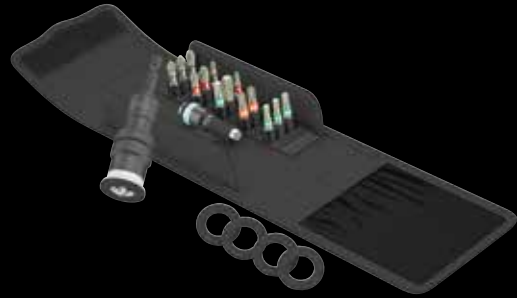

Set de scule compacte Wera cu cele mai utilizate 17 scule de insurubat pentru constructia de terase. 1 suport de biti cu limitare variabila a adancimii suruburilor, cu inel de retinere pentru o mentinere sigura a bitilor, 4 inele de pasla de rezerva, care previn urmele de zgaraieturi pe pardoseala terasei, 1 suport de bit Rapidaptor Stainless cu mandrina cu eliberare rapida, 15 biti din otel inoxidabil pentru a preveni contaminarea cu rugina. Identificator - Find it easy : codificarea pe culori in conformitate cumarcajul dimensional si profil ceea ce ajuta la identificarea rapida a bitului necesar.

05134021001		
⊙ ⊙	881/4/1	1x 1/4"x90 ¹⁾
⊙ ⊙	3888/4/1 K	1x 1/4"x50
+	3851/1 TS PH	1x PH 1x25; 1x PH 2x25; 1x PH 3x25
+	3855/1 TS PZ	1x PZ 1x25; 2x PZ 2x25; 1x PZ 3x25
⊙	3867/1 TS TORX®	1x TX 10x25; 1x TX 15x25; 1x TX 20x25; 1x TX 25x25; 1x TX 30x25; 1x TX 40x25
⊙	3867/1 TS P TORX®	2x TX 25x25
	9201	4x 27.0

¹⁾Setul de piese de schimb cu 5x inele de păsă poate fi comandat cu numărul de cod 05130003001.



Încasarea uniformă a șuruburilor



Suportul de biți 881/4/1 permite insurubari la nivel uniforme la constructia teraselor. Adâncimea șurubului poate fi reglată după cum este necesar. Acest lucru împiedică șuruburile să fie înfundate prea adânc.

Vermeidet Fäulnisschäden



Capul șurubului este la nivel cu podeaua, prin urmare se evită așa-numitele „cuiburi de apă”, care de obicei duc la putrezire.



Competența noastră

Wera este unul din cei mai importanți producători de scule pentru insurubat, având sediul social în Wuppertal, Germania. Wera dezvoltă și produce scule pentru aplicații profesionale, industriale și este furnizor de soluții pentru problemele asociate cu ansamblările cu șuruburi.

Unelte create din idei

Wera fascinează mereu utilizatorii cu idei de produse excepționale. În aplicații practice, aceste idei, cu propriile lor caracteristici unice, au drept rezultat o experiență cu adevărat profesionistă a insurubarilor.

Gamă cuprinzătoare

Gama constă din peste 3.000 de produse și include soluții autentice pentru probleme, chiar și pentru aplicații foarte specifice.

Producător de calitate

Calitatea trebuie să corespundă. Aceasta se asigură printr-un proces de fabricație monitorizat continuu, și drept rezultat: numărul de reclamații este apropiat de zero. Desigur, Wera este certificată ISO.

Drepturi asupra mărcii și a mărcilor comerciale

Wera este producător de produse de marcă și partener de încredere pentru industrie, domeniu și utilizatori. Numeroase drepturi asupra unor mărci comerciale, instituite în întreaga lume, ne protejează clienții contra imitațiilor substandard. Produsele Wera beneficiază de garanție în privința funcționării sigure, fiabile și a performanței imbatabile.

Designul produselor

Sculele Wera au stil și sunt ergonomice, și Wera a câștigat mai multe premii pentru designul produselor sale. A lucra cu produse Wera înseamnă a înțelege ce înseamnă cu adevărat designul.

Logistică de încredere

Capacitatea noastră de a livra orice produs din catalog este de aproape 100 %. Desigur, livrăm în întreaga lume.



Wera Werkzeuge GmbH
Korzertter Straße 21–25
D-42349 Wuppertal

Phone: +49 (0)2 02 / 40 45-0
Fax: +49 (0)2 02 / 40 45 276
E-Mail: info@wera.de

www.wera.de



RD 05 500617 022 - 0053701 - 01